

megagen



MODEL Z120 & Z150 OPERATOR'S MANUAL

LIMITED **megagen** Z SERIES WARRANTY

This limited warranty is issued by **megagen** for the supply of the following products: **megagen Z Series Generators**.

2 DESCRIPTION AND WARRANTY PERIOD

Machine: Without prejudice to the legal warranty, **megagen** extends the warranty on manufacturing defects relating to the equipment supplied up to a period of 4 (four) years/ 4000 hour (whichever comes first) from the date of sale (invoice). Therefore, the total legal and limited warranty period will be 4 (four) years/ 4000 hour (whichever comes first) from the invoice date. The determination whether the product is defective will be made by Axiom Equipment Inc. in its sole discretion, considering the general performance given by the product.

3 WARRANTY TERMS AND CONDITIONS

The guarantee is valid provided that:

- The products are stored, installed, used and maintained in compliance with the technical specifications indicated in the product marking (with specific reference to the voltage and operating temperature), to the instructions supplied with the product, to what is indicated in the respective catalogs and to the standards in force;
- Installation and maintenance are carried out by qualified technical personnel, all service records must be available for warranty purposes;
- The reported defect affects the functionality of the product;
- The product has not been modified, altered or treated with chemicals or in any other way in any way;
- The product covered by the guarantee is made available to **megagen** for further technical analysis for the time necessary to carry it out;
- The defect is reported in writing, by certified or registered email with return receipt to **megagen** within 30 (thirty) days from the receipt of the products (in the case of apparent defects) or from the discovery of the defect (in the case of hidden defects) by sending a photographic feedback of the label on the product;

In the event that the defect is recognized by **megagen**, **megagen** will choose at its discretion whether to repair or replace the defective product with the same product or an equivalent one, taking into consideration the technical evolution of the products and that of their components. Any technical intervention or replacement (partial or complete) of the product carried out pursuant to the warranty will not in any case give the right to extensions or renewals of the same beyond 4 (four) years/ 4000 hour (whichever comes first) from the invoice date. The repair and replacement of the product recognized as defective by Axiom Equipment Inc. does not include costs or expenses for its removal or reinstallation. Axiom Equipment Inc. is not responsible for, and therefore will not reimburse, any consequential loss or indirect, compensatory or other damage suffered due to a defective products, such as, by way of example and not limited to, shipping costs, assembly costs, on-site installation, any downtime costs, loss of profit or overall cost of buyers.

4. EXCLUSIONS AND LIMITATIONS

This limited warranty does not cover:

- Labour costs and expenses, equipment and warehouse costs and expenses, or any other extra costs relating to and / or resulting from any intervention necessary to repair the defect (such as, by way of example, costs / expenses for assembly, disassembly, and transport of defective appliances, to be repaired or new products which will be the sole responsibility of the customer);
- Electrical products subject to wear which are comparable to consumables;
- Products made on specific customer request;
- Damage to products due to negligence, transportation or unforeseen and unforeseeable events that do not fall within normal conditions of use (such as, for example, electric shock and lightning);
- Appliances not used for the purpose for which they were made;

This warranty does not guarantee the integrity of the painting when the product is used in a saline environment or in the presence of corrosive agents.

In no event **megagen** will be liable for accidental, compensatory, consequential, indirect, special or other damages. The liability of **megagen** for a defect in the product will in any case be limited to the amount actually paid for that defective product.

The performance and duration of the LEDs are not guaranteed if the fixtures are installed in environments with the presence of chemical substances that are not compatible with the LEDs themselves. Our technical office is available to check the compatibility of the LEDs we use in relations to the substances present in the environment where the luminaires are installed.

5. APPLICABLE LAW AND JURISDICTION

This limited warranty, as well as its execution, interpretation and all questions concerning the validity and effectiveness of the same, will be governed by Canadian Law.

It is the responsibility of the owner to register the engine and alternator with each OEM for warranty purposes.

SPARE PARTS

Spare parts manual is available for this unit.

WARRANTY VOID IF NOT REGISTERED



ELECTRIC POWER GENERATOR

WARRANTY REGISTRATION FORM & INSPECTION REPORT

WARRANTY REGISTRATION

This form must be filled out by the dealer and signed by both the dealer and the customer at the time of delivery.

Customer's Name _____ Dealer's Name _____
 Address _____ Address _____
 City, State/Prov., Code _____ City, State/Prov., Code _____
 Phone Number (_____) _____
 Generator Model _____
 Serial Number Alternator _____
 Unit Serial Number _____
 Serial Number Engine _____
 Delivery Date _____

DEALER INSPECTION REPORT

_____ Tire Pressure Checked (If on trailer)
 _____ Wheel Bolts Torqued (If on trailer)
 _____ Inspect Electrical System
 _____ Check Oil Level in Hydraulic Reservoir
 _____ Lubricate Machine
 _____ Check Engine Fluid Levels

SAFETY

_____ Guards/Shields Installed & Secured
 _____ All Decals Installed & Legible
 _____ Safety Chain on Hitch (If on trailer)
 _____ Review Operating and Safety Instructions

I have thoroughly instructed the buyer on the above described equipment which review included the Operator's Manual content, equipment care, adjustments, safe operation and applicable warranty policy.

Date _____ Dealer's Rep. Signature _____

Signature _____

The above equipment and Operator's Manual have been received by me and I have been thoroughly instructed as to care, adjustments, safe operation and applicable warranty policy.

Date _____ Owner's Signature _____

WHITE	YELLOW	PINK
MEGAGEN	DEALER	CUSTOMER

SERIAL NUMBER LOCATIONS

Always give your dealer the serial number of your **megagen** Z120 and Z150 generators when ordering parts or requesting service or other information.

The serial number plates are located where indicated. Please mark the number in the space provided for easy reference.

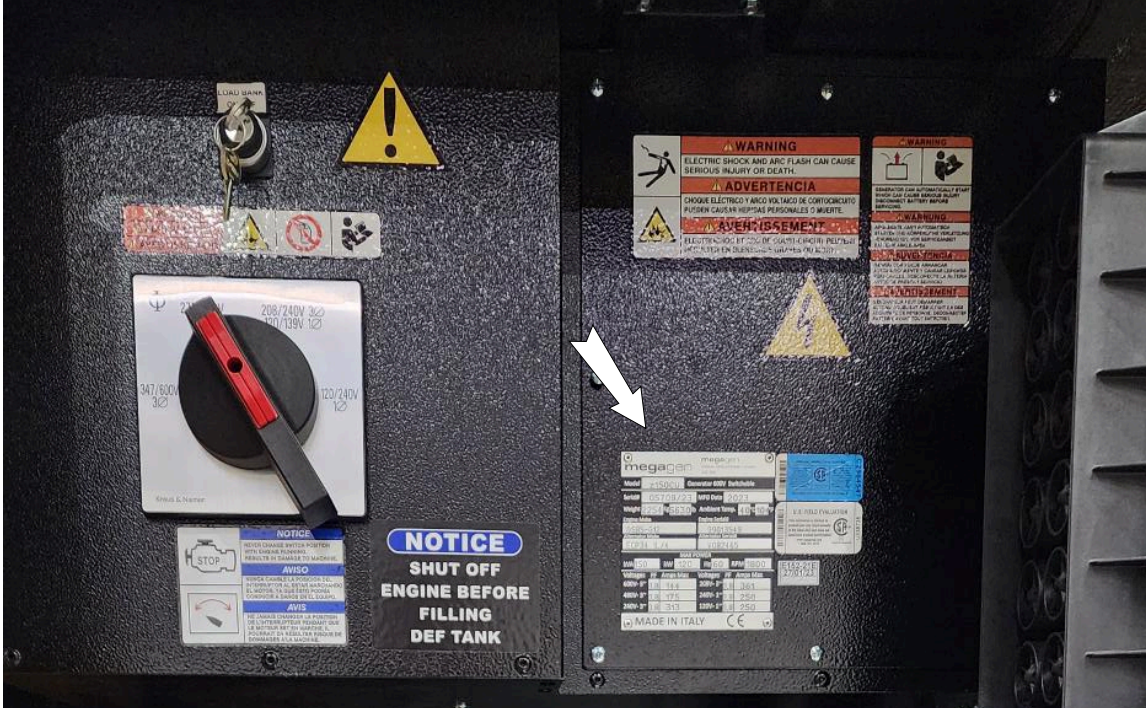

Z120 / Z150

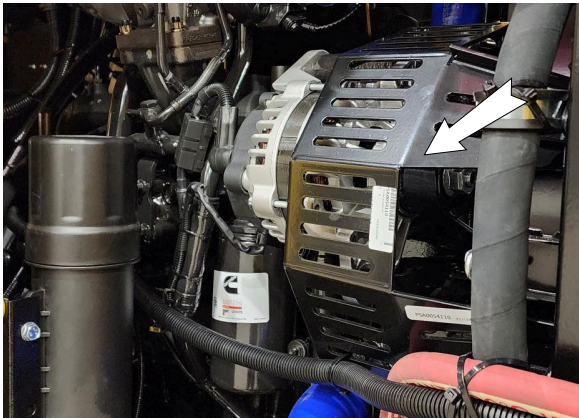

ENGINE

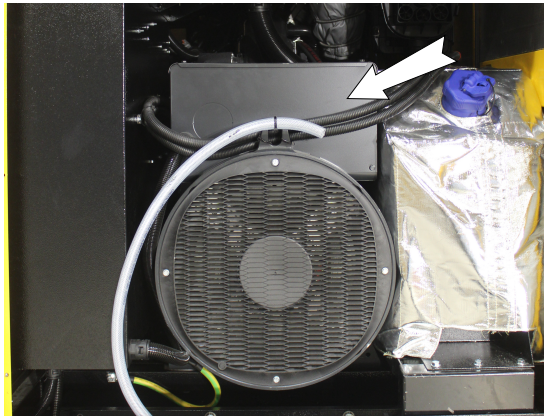

ALTERNATOR

Model	Z120 / Z150	
Serial Number	Machine	_____
	Engine	_____
	Alternator	_____

TABLE OF CONTENTS

SECTION	DESCRIPTION	PAGE
1	Introduction	1
2	Safety	3
2.1	General Safety	4
2.2	Equipment Safety Guidelines	5
2.3	Safety Training	6
2.4	Safety Signs.....	6
2.5	Storage Safety	6
2.6	Preparation Safety	7
2.7	Installation Safety	7
2.8	Maintenance Safety	8
2.9	Lock-Out Tag-Out Safety.....	8
2.10	Battery Safety	8
2.11	Operating Safety.....	9
2.12	Tire Safety.....	9
2.13	Transport Safety.....	9
2.14	Electrical Safety	9
2.15	Diesel Engine Safety	10
2.16	Refueling Safety.....	10
2.17	Refilling DEF Safety.....	11
2.18	Sign-Off Form	12
3	Safety Sign Locations	13
4	Operation.....	15
4.1	To the New Operator or Owner.....	15
4.2	Machine Components.....	16
4.3	Machine Break-In.....	18
4.4	Pre-Operation Checklist.....	18
4.5	Controls	19
4.6	Machine Preparation.....	22
4.7	Operation.....	26
4.9	Storage	31
4.12	Transport.....	32
5	Service and Maintenance.....	35
5.1	Service.....	35
5.2	Maintenance	41
6	Trouble Shooting	45
7	Specifications	47
7.1	Mechanical.....	47
7.2	Bolt Torque.....	49
7.3	Electrical Schematic	50
8	Index	51

1 INTRODUCTION

Congratulations on your choice of a **megagen** Z120/Z150 generator and welcome to **megagen's** quality line of generating equipment. This equipment is designed and manufactured to meet the needs of a customer who needs a portable, cost-effective source of electrical power.

Safe, efficient and trouble free operation of your new **megagen** Z120/Z150 generator requires that you, and any-one else who will be operating or maintaining the machine, read, understand and practice ALL of the Safety, Operation, Maintenance and Trouble Shooting recommendations contained within this Operator's Manual.



This manual applies to all Z120 and Z150 generators manufactured by **megagen**. Certain options may be available to specifically tailor the generator to your operation and may not be included in this manual. Please contact the manufacturer regarding additional information about these options. Use the Table of Contents and Index as a guide to find specific information.

The information in this manual is accurate based on products produced at the time of publication. The manufacturer reserves the right to make technical updates, corrections and product revisions at any time without notice.

The warnings in this manual and on decals on the unit are not all inclusive. If using a procedure or operating techniques that the manufacturer does not specifically recommend, verify that it is safe for others. Also, make sure the procedure does not render the equipment unsafe.

Keep this manual handy for frequent reference and so that it will be passed on to new operators or owners. Call your **megagen** dealer if you need assistance, information or additional copies of this manual.

2 SAFETY

SAFETY ALERT SYMBOL

This Safety Alert symbol means
**ATTENTION! BECOME ALERT!
YOUR SAFETY IS INVOLVED!**

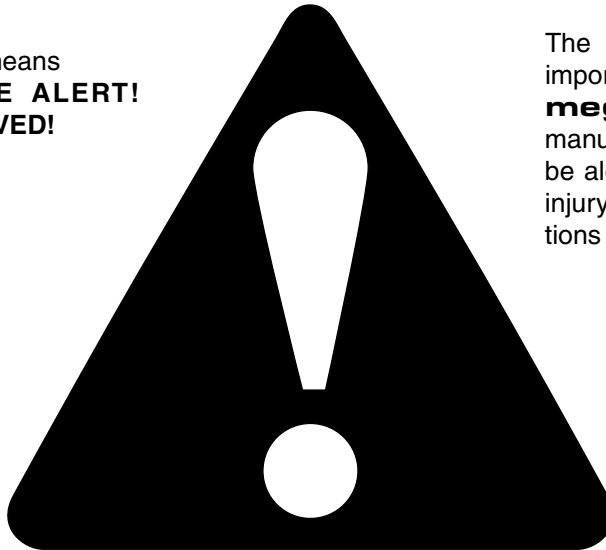

The Safety Alert symbol identifies important safety messages on your **megagen** generator and in the manual. When you see this symbol, be alert to the possibility of personal injury or death. Follow the instructions in the safety message.

Why is SAFETY important to you?

3 Big Reasons

**Accidents Disable and Kill
Accidents Cost You Money
Accidents Can Be Avoided**

SIGNAL WORDS:

Note the use of the signal words **DANGER**, **WARNING** and **CAUTION** with the safety messages. The appropriate signal word for each message has been selected using the following guide-lines:

- | | |
|------------------|--|
| DANGER - | Indicates an imminently hazardous situation that, if not avoided, will result in death or serious injury. This signal word is to be limited to the most extreme situations, typically for machine components that, for functional purposes, cannot be guarded. |
| WARNING - | Indicates a potentially hazardous situation that, if not avoided, could result in death or serious injury, and includes hazards that are exposed when guards are removed. It may also be used to alert against unsafe practices. |
| CAUTION - | Indicates a potentially hazardous situation that, if not avoided, may result in minor or moderate injury. It may also be used to alert against unsafe practices. |

If you have any questions not answered in this manual or require additional copies or the manual is damaged, please contact your dealer or **megagen**, Phone: 1-866-918-6976, Email: service@axiomequipmentgroup.com.



SAFETY

YOU are responsible for the **SAFE** operation and maintenance of your **megagen** generator. **YOU** must ensure that you and anyone else who is going to operate, maintain or work around the machine be familiar with the operating and maintenance procedures and related **SAFETY** information contained in this manual. This manual will take you step-by-step through your working day and alerts you to all good safety practices while operating the generator.

Remember, **YOU** are the key to safety. Good safety practices not only protect you but, also the people around you. Make these practices a working part of your safety program. Be certain that **EVERYONE** operating this machine is familiar with the procedures recommended and follows safety precautions. Remember, most accidents can be prevented. Do not risk injury or death by ignoring good safety practices.

- Read and understand the Operator's Manual and all safety signs before supplying power to, operating, maintaining or adjusting the generator.
- Generator owners must give operating instructions to operators or employees before allowing them to operate the machine, and at least annually thereafter.
- The most important safety device on this equipment is a SAFE operator. It is the operator's responsibility to read and understand ALL Safety and Operating instructions in the manual and to follow these. Most accidents can be avoided.
- A person who has not read and understood all operating and safety instructions is not qualified to operate this machine. An untrained operator exposes himself and bystanders to possible serious injury or death.
- Do not modify the equipment in any way. Unauthorized modification may impair the function and/or safety and could affect the life of the equipment.
- The manual comes with the original documentation for the engine and the alternator: we recommend keeping it all in a safe place and have qualified personnel to carry out operations. In case of transfer of equipment ownership, attach all the documentation, as it is an integral part of the product.
- Our customer service and technical assistance department is available to assist you in any way.
- Only use genuine parts in case replacement is required; failure to comply will void your warranty automatically.

2.1 GENERAL SAFETY

- Read and understand the Operator's Manual and all safety signs before supplying power to, operating, maintaining or adjusting the generator. 
- Only trained, competent persons shall operate the generator. An untrained operator is not qualified to operate this machine.
- Provide a first-aid kit for use in case of an accident. Store in a highly visible place. 

- Provide a fire extinguisher for use in case of an accident. Store in a highly visible place.
- Install and properly secure all guards and shields before operating.

- Wear appropriate protective gear. This list includes but is not limited to:
 - Protective shoes with slip resistant soles
 - Protective glasses or goggles
 - Heavy gloves
 - Hearing protection
- Turn machine OFF, place all controls in their OFF position, shut down and lockout power supply, and wait for all moving parts to stop before servicing, adjusting, maintaining, repairing or cleaning.
- Do not damage this manual, do not remove or tear any pages and keep it away from moisture and heat sources. Please note that the drawings contained in the manual are merely to help you identify the parts described and, therefore, they might not correspond precisely to your product.
- Know the emergency medical center number for your area.
- Review safety related items with all operators annually.



2.2 EQUIPMENT SAFETY GUIDELINES

- Safety of the operator and bystanders is one of the main concerns in designing and developing a machine. However, every year many accidents occur which could have been avoided by a few seconds of thought and a more careful approach to handling equipment. You, the operator, can avoid many accidents by observing the following precautions in this section. To avoid personal injury or death, study the following precautions and insist those working with you, or for you, follow them.
- In order to provide a better view, certain photographs or illustrations in this manual may show an assembly with a safety shield removed. However, equipment should never be operated in this condition. Keep all shields in place. If shield removal becomes necessary for repairs, replace the shield prior to use.
- Replace any safety sign or instruction sign that is not readable or is missing. Location of such safety signs is indicated in this manual.
- Never use alcoholic beverages or drugs which can hinder alertness or coordination while operating this equipment. Consult your doctor about operating this machine while taking prescription medications.
- **Under no circumstances should young children be allowed to work with this equipment. Do not allow persons to operate or assemble this unit until they have read this manual and have developed a thorough understanding of the safety precautions and of how it works.** Review the safety instructions with all users annually.
- This equipment is dangerous to children and persons unfamiliar with its operation. The operator should be a responsible, properly trained and physically able person familiar with the machinery and trained in this equipment's operations. If the elderly are assisting with work, their physical limitations need to be recognized and accommodated.
- Never exceed the limits of a piece of machinery. If its ability to do a job, or to do so safely, is in question - **DON'T TRY IT.**
- Do not modify the equipment in any way. Unauthorized modification result in serious injury or death and may impair the function and life of the equipment.
- The contents of this manual are not binding. The manufacturer reserves the right to make changes and improvements to accessories and details without altering the essential characteristics of the model described and illustrated here and without committing to promptly updating this manual.
- In addition to the design and configuration of this implement, including Safety Signs and Safety Equipment, hazard control and accident prevention are dependent upon the awareness, concern, prudence, and proper training of personnel involved in the operation, transport, maintenance, and storage of the machine. Refer also to Safety Messages and operation instruction in each of the appropriate sections of the auxiliary equipment and machine Manuals. Pay close attention to the Safety Signs affixed to the auxiliary equipment and the machine.
- This machine is designed to generate high voltage electrical power that can injure or kill if not operated properly. Read operator's manual and follow all instructions.

2.3 SAFETY TRAINING

- Safety is a primary concern in the design and manufacture of our products. Unfortunately, our efforts to provide safe equipment can be wiped out by a single careless act of an operator or bystander.
- In addition to the design and configuration of equipment, hazard control and accident prevention are dependent upon the awareness, concern, prudence and proper training of personnel involved in the operation, transport, maintenance and storage of this equipment.
- It has been said, "The best safety feature is an informed, careful operator." We ask you to be that kind of an operator. It is the operator's responsibility to read and understand ALL Safety and Operating instructions in the manual and to follow these. Accidents can be avoided.
- **Working with unfamiliar equipment can lead to careless injuries. Read this manual, and the manual for your auxiliary equipment, before assembly or operating, to acquaint yourself with the machines. If this machine is used by any person other than yourself. It is the machine owner's responsibility to make certain that the operator, prior to operating:**
 - i. **Reads and understands the operator's manuals.**
 - ii. **Is instructed in safe and proper use.**
- Know your controls and how to stop generators and any other auxiliary equipment quickly in an emergency. Read this manual and the one provided with your other equipment.
- Train all new personnel and review instructions frequently with existing workers. Be certain only a properly trained and physically able person will operate the machinery. A person who has not read and understood all operating and safety instructions is not qualified to operate the machine. An untrained operator exposes himself and bystanders to possible serious injury or death. If the elderly are assisting with work, their physical limitations need to be recognized and accommodated.



2.4 SAFETY SIGNS

- Keep safety signs clean and legible at all times.
- Replace safety signs that are missing or have become illegible.
- Replaced parts that displayed a safety sign should also display the current sign.
- Safety signs displayed in Section 3 each have a part number in the lower right-hand corner. Use this part number when ordering replacement parts.
- Safety signs are available from your authorized Distributor or Dealer Parts Department or the factory.

How to Install Safety Signs:

- Be sure that the installation area is clean and dry.
- Be sure temperature is above 50°F (10°C).
- Determine exact position before you remove the backing paper. (See Section 3).
- Remove the smallest portion of the split backing paper.
- Align the sign over the specified area and carefully press the small portion with the exposed sticky backing in place.
- Slowly peel back the remaining paper and carefully smooth the remaining portion of the sign in place.
- Small air pockets can be pierced with a pin and smoothed out using the piece of sign backing paper.

2.5 STORAGE SAFETY

- Store the generator on a firm level surface.
- If required, make sure the unit is firmly blocked up.
- Make certain that all mechanical locks and jacks are safely and positively connected before storing.
- Store away from areas of human activity.
- Do not allow children to play on or around the stored generator.
- Lock out power by turning off master control panel or junction box and padlocking the door shut to prevent electrocution or unauthorized start up of the generator.
- If mounted on a trailer, place chocks in front of and behind the tires before unhooking from tow vehicles.

2.6 PREPARATION SAFETY

- Never operate the generator and auxiliary equipment until you have read and completely understand this manual, the auxiliary equipment Operator's Manual, and each of the Safety Messages found on the safety signs on the generator and auxiliary equipment.

- Personal protection equipment including hard hat, safety glasses, safety shoes, and gloves are recommended during assembly, installation, operation, adjustment, maintaining, repairing, or moving the generator. Do not allow long hair, loose fitting clothing or jewelry to be around equipment.



- **PROLONGED EXPOSURE TO LOUD NOISE MAY CAUSE PERMANENT HEARING LOSS!**

Motors or equipment attached can often be noisy enough to cause permanent, partial hearing loss. We recommend that you wear hearing protection on a full-time basis if the noise in the Operator's position exceeds 80db. Noise over 85db on a long-term basis can cause severe hearing loss. Noise over 90db adjacent to the Operator over a long-term basis may cause permanent, total hearing loss. **NOTE:** Hearing loss from loud noise (from tractors, chain saws, radios, and other such sources close to the ear) is cumulative over a lifetime without hope of natural recovery.

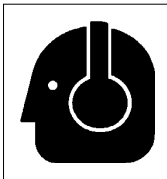

- Clear working area of debris, trash or hidden obstacles that might be hooked or snagged, causing injury, damage or tripping.
- Operate only in daylight or good artificial light.
- Be sure machine is properly anchored, adjusted and in good operating condition.
- Ensure that all safety shielding and safety signs are properly installed and in good condition.
- Before starting, give the machine a "once over" for any loose bolts, worn parts, cracks, leaks, frayed belts and make necessary repairs. Always follow maintenance instructions.

2.7 INSTALLATION SAFETY

- Review layout of the worksite. Position generator where it can provide maximum power with minimal interference with the access and operation of other equipment. Select a different position if there is interference.
- Position generator base or trailer on a solid, level surface to avoid tipping, sliding or falls during operation. Avoid placing the unit on a surface with a slope of over 10°.
- Position machine so the engine exhaust is directed away from personnel on the worksite. Direct the gases away from the worksite.
- Use ground terminal inside frame to ground unit in compliance with local laws and regulations.
- Do not operate machine with wet hands or clothing.
- All electrical wires, plugs, sockets and other components must always be in good condition when operating.
- Close and latch the doors during normal operation. Open and latch the doors when the engine is stopped and machine is being serviced.
- Keep engine cooling slots on doors and frame clean to allow engine to cool when running. Clean when trash plugs slots.
- Do not place any items next to exhaust or muffler to prevent burns or items from catching on fire from high temperatures.
- Stop engine and disconnect power if a malfunction occurs. Identify and resolve the malfunction before turning machine on and resuming work.

2.8 MAINTENANCE SAFETY

- Read and understand all the information contained in the Operator's Manual regarding operating, servicing, adjusting, maintaining and repairing.
- **Turn machine OFF, shut down and lock out power supply and wait for all moving parts to stop before servicing, adjusting, maintaining or repairing.**
- Follow good shop practices:

- Keep service area clean and dry.
- Be sure electrical outlets and tools are properly grounded.
- Use adequate light for the job at hand.



- Make sure all guards and doors are in place and properly secured when operating the generator.
- Do not work on generator electrical system unless the power cord is unplugged or the power supply is locked out. Lock-out tag-out power source before performing any maintenance work.



- A fire extinguisher and first aid kit should be kept readily accessible while performing maintenance on this equipment.

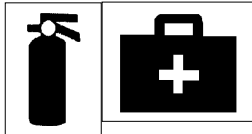

- Disconnect load from power supply and wait for all moving parts to stop before performing any service or maintenance or work on them.
- Do not touch engine, manifold, pipes and muffler while engine is running. Allow engine to cool before performing any service work on it.
- Always replace guards and shields and close doors when service and repair work has been completed.
- Do not remove radiator cap when engine is running or still hot to prevent leaks and scalding burns.

2.9 LOCK-OUT TAG-OUT SAFETY

- Establish a formal Lock-Out Tag-Out program for your operation.
- Train all operators and service personnel before allowing them to work around the generator.
- Provide tags at the work site and a sign-up sheet to record tag out details.
- Do not service or maintain the generator unless motor is OFF and the power locked out with the master switch.

2.10 BATTERY SAFETY

- Keep all sparks and flames away from batteries, as gas given off by electrolyte is explosive. Always wear gloves.
- Avoid contact with battery electrolyte: wash off any spilled electrolyte immediately.
- Wear safety glasses when working near batteries.
- Do not tip batteries more than 45° to avoid electrolyte loss.
- To avoid injury from spark or short circuit, disconnect battery ground cable before servicing any part of the electrical system.

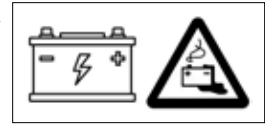

2.11 OPERATING SAFETY

- Read and understand the Operator's Manual and all safety signs before operating, maintaining, adjusting or repairing the generator.
- Turn machine OFF, place master controls in their OFF position shut down and lock out power source, unplug power cord and wait for all moving parts to stop before servicing, adjusting, repairing or unplugging.
- Keep all electrical components tight, dry and in good repair.
- Clear the area of bystanders, especially small children.
- Replace all worn or failed components immediately with **megagen** approved parts.
- Install and secure all guards before operating.
- Keep hands, feet, hair and clothing away from moving parts.
- Review worksite. Position generator to provide electrical power accessibility and minimal interference with other equipment.
- The unit generates sufficient electrical power to injure or kill. Follow appropriate safety procedures.
- Establish a formal Lock-Out/Tag-Out program for your operation and train all operators and service personnel before allowing them work with and around the generator.
- Require all personnel to use Personal Protective Equipment (PPE) when operating or servicing the machine.
- Do not stand or climb on machine when running. Keep others off.
- Keep the working area clean and dry.
- Review safety instructions annually.

2.12 TIRE SAFETY

- Failure to follow proper procedures when mounting a tire on a wheel or rim can produce an explosion which may result in serious injury or death.
- Do not attempt to mount a tire unless you have the proper equipment and experience to do the job.
- Have a qualified tire dealer or repair service perform required tire maintenance.
- When replacing worn tires, make sure they meet the original tire specifications. Never under-size.

2.13 TRANSPORT SAFETY

- Make certain that you are in compliance with local, state/provincial and federal regulations regarding transporting equipment on public roadways.
- Make certain that all wheels and tires are in good repair and that tires are inflated to proper pressure. Do not under-inflate or over-inflate.
- Make certain that all wheel bolts/lug nuts are tightened to proper torque specifications (refer to specification chart in Section 7.2).
- Secure and lock access doors before transporting.
- Raise jack into its fully UP position and secure with lock pin.
- Do not park generator on a steep slope.
- Be sure that any necessary signs, reflectors and lights required by law are in proper place and are clearly visible to oncoming and overtaking traffic.
- Be sure that the generator is positively hitched to the towing vehicle. Use a safety cable to assure a safe hitch hook-up when transporting.
- Use a 3/4 ton pickup or larger truck to tow machine.
- Do not allow anyone to ride on the generator during transport.
- Clear the area of obstacles and unnecessary personnel.
- Do not place any objects or loads on the frame to prevent changing the center of gravity or overloading the frame.
- Do not exceed a safe travel speed of 90 km/55mph with trailer. Slow down for corners and rough surface conditions.

2.14 ELECTRICAL SAFETY

- Use the terminal inside the frame to ground unit in compliance with local laws and regulations.
- All electrical wires, plugs, sockets and other components must always be in good condition when operating.
- Turn master battery and electrical switches off when shutting down unit.
- Do not operate machine with wet hands or clothing.

2.15 DIESEL ENGINE SAFETY

BEFORE STARTING ENGINE, READ AND UNDERSTAND THE OPERATING AND MAINTENANCE INSTRUCTIONS THAT CAME WITH YOUR ENGINE.

WARNING: DO NOT

- DO NOT run engine in an enclosed area. Exhaust gases contain carbon monoxide, an odorless and deadly poison.
- DO NOT place hands or feet near moving or rotating parts.
- DO NOT store, spill, or use fuel near an open flame, or devices such as a stove, furnace, or water heater which use a pilot light or devices which can create a spark.
- DO NOT refuel indoors where area is not well ventilated. Outdoor refuelling is preferred.
- DO NOT fill fuel tank while engine is running. Allow engine to cool for 5 minutes before refuelling. Store fuel in approved safety containers.
- DO NOT remove fuel tank cap while engine is running.
- DO NOT operate engine if fuel is spilled. Move machine away from the spill and avoid creating any ignition until the fuel has evaporated.
- DO NOT smoke when filling fuel tank.
- Whenever possible, gradually reduce engine speed before stopping.
- DO NOT run engine above rated speeds. This may result in injury.
- DO NOT tamper with parts which may increase the governed engine speed.
- DO NOT tamper with the engine speed selected by the original equipment manufacturer.
- DO NOT strike flywheel with a hard object or metal tool as this may cause flywheel to shatter in operation. Use proper tools to service engine.
- DO NOT operate engine without a muffler. Inspect periodically and replace, if necessary. If engine is equipped with muffler deflector, inspect periodically and replace, if necessary with correct deflector.
- DO NOT operate engine with an accumulation of grass, leaves, dirt or other combustible materials in the muffler area.
- DO NOT use this engine on any forest covered, brush covered, or grass covered unimproved land unless a spark arrester is installed on the muffler. The arrester must be maintained in effective working order by the operator. In the State of California the above is required by law (Section 4442 of the California Public Resources Code). Other states may have similar laws. Federal laws apply on federal lands.
- DO NOT touch hot muffler, cylinder or manifold because contact may cause burns.

- DO NOT run engine with air cleaner or air cleaner cover removed.

WARNING: DO

- ALWAYS disconnect battery before servicing engine to prevent accidental starting.
- DO examine muffler periodically to be sure it is functioning effectively. A worn or leaking muffler should be repaired or replaced as necessary.
- DO use fresh fuel. Stale fuel can gum fuel injection system.
- DO check fuel lines and fittings frequently for cracks or leaks. Replace if necessary.

2.16 REFUELLING SAFETY

- Handle fuel with care. It is highly flammable.
- Allow engine to cool for 5 minutes before refuelling. Clean up spilled fuel before restarting engine.
- Do not refuel the machine while smoking or when near open flame or sparks.
- Fill fuel tank outdoors.
- Prevent fires by keeping machine clean of accumulated trash, grease and debris.



2.17 REFILLING DEF SAFETY

Composition

Diesel Exhaust Fluid (DEF) is made from a mixture of purified water and urea. The formula is stable, colorless, non-toxic, and similar to baking soda in its alkalinity (pH). It is not a fuel, but it is used to reduce the level of nitrogen oxides in the exhaust to meet emissions control standards.

Purpose

In the Selective Catalytic Reduction (SCR) system, DEF is injected into the exhaust. It converts the NO₂ into nitrogen gas and water vapor, which are harmless components of air.

Storing

The ideal temperature range for storing DEF is between 32°F and 86°F, and its average shelf life is 3 years. Keep DEF out of direct sunlight, and do not store it in temperatures below 32°F. Because of its alkalinity, DEF fluid can cause oxidization in the same way that oxygen rusts raw steel, so it needs to be stored in plastic or stainless steel containers.

What to know when filling your DEF tank

DEF tanks are designed so that the opening will only accept a DEF fill nozzle. A standard nozzle for diesel fuel will not fit into the DEF tank opening. This safeguard ensures that only the proper fluid can be pumped into the tank.

DEF tanks will hold between 15 and 50 gallons, depending on the size and horsepower of your equipment. Be sure to keep enough reserves on hand, as equipment will cease to operate once the DEF tank is dry.

When to refill the tank

A DEF gauge has been added to most new equipment that will show the fluid level and indicate when it is time to refill.

When the DEF fluid level reaches less than 10% capacity, a series of warnings will alert the operator. If the DEF tank contains less than 5% of its capacity, the equipment engine power will de-rate. The DEF tank needs to be filled once for every 3 to 4 times that you refuel with diesel fuel. The frequency will vary with operating conditions.

3 SAFETY SIGN LOCATIONS

The types of safety signs and locations on the equipment are shown in the illustrations that follow. Good safety requires that you familiarize yourself with the various Safety Signs, the type of warning and the area, or particular function related to that area, that requires your SAFETY AWARENESS.

- Think SAFETY! Work SAFELY!



A

CAUTION

- Read and understand the Operator's Manual and all safety signs before operating, maintaining, adjusting or repairing the generator.
- Turn machine OFF, place master controls in their OFF position shut down and lock out power source, unplug power cord and wait for all moving parts to stop before servicing, adjusting, repairing or unplugging.
- Keep all electrical components tight, dry and in good repair.
- Clear the area of bystanders, especially small children.
- Replace all worn or failed components immediately with Axiom approved parts.
- Install and secure all guards before operating.
- Keep hands, feet, hair and clothing away from moving parts.
- Review worksite. Position generator to provide electrical power accessibility and minimal interference with other equipment.
- The unit generates sufficient electrical power to injure or kill. Follow appropriate safety procedures.
- Establish a formal Lock-Out/Tag-Out program for your operation and train all operators and service personnel before allowing them work with and around the generator.
- Require all personnel to use Personal Protective Equipment (PPE) when operating or servicing the machine.
- Do not stand or climb on machine when running. Keep others off.
- Keep the working area clean and dry.
- Review safety instructions annually.

B

DANGER

ELECTROCUTION HAZARD

- Stop engine, turn all controls off, unplug power cords and wait for all moving parts to stop before servicing or repairing electrical components.
- Keep electrical components dry and in good repair.

Failure to follow these instructions can result in serious injury or death.

C

DANGER

FIRE HAZARD
NO SMOKING

To prevent serious injury or death from fire:

- Stop engine before refueling.
- Do not smoke while refueling.
- Keep sparks, flames and hot materials away from flammable substances.

19452

REMEMBER - If Safety Signs have been damaged, removed, become illegible or parts replaced without safety signs, new signs must be applied. New safety signs are available from your authorized dealer.

The types of safety signs and locations on the equipment are shown in the illustrations that follow. Good safety requires that you familiarize yourself with the various Safety Signs, the type of warning and the area, or particular function related to that area, that requires your SAFETY AWARENESS.

- Think SAFETY! Work SAFELY!

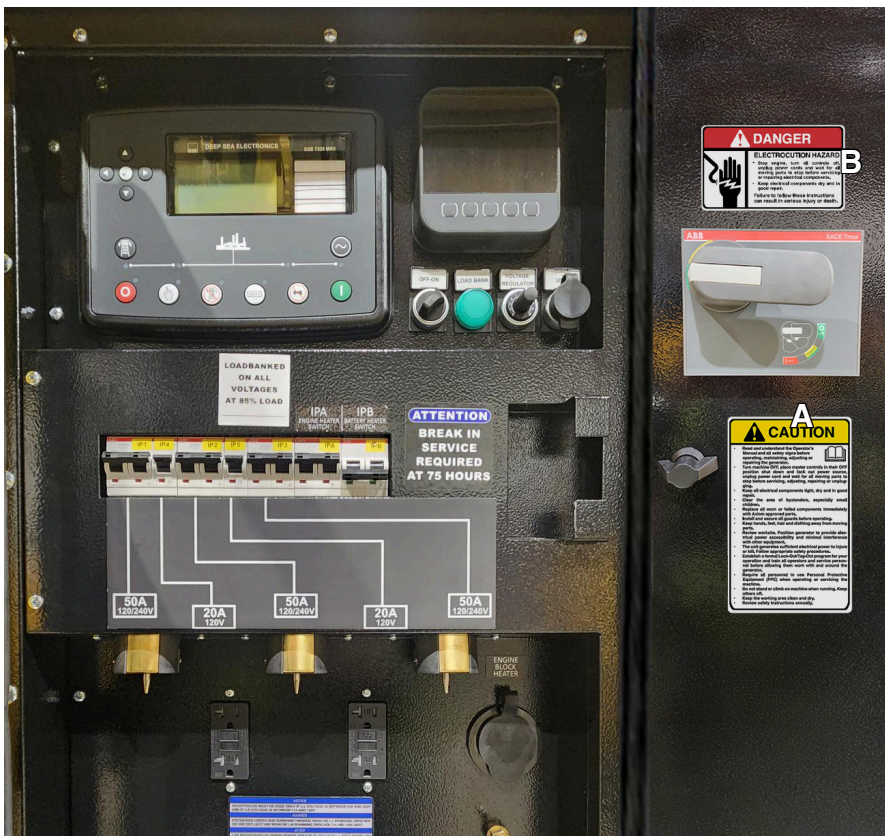
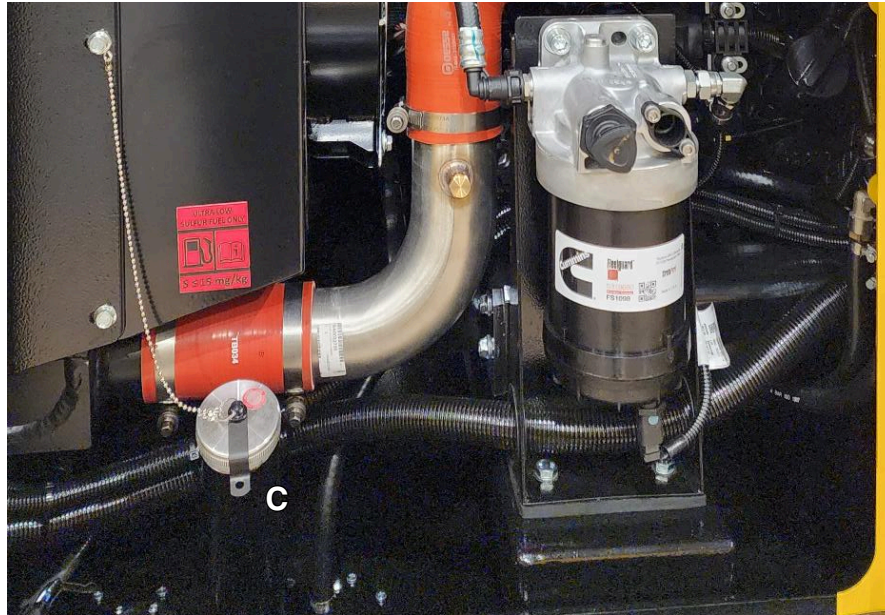

REMEMBER - If Safety Signs have been damaged, removed, become illegible or parts replaced without safety signs, new signs must be applied. New safety signs are available from your authorized dealer.

4 OPERATION



OPERATING SAFETY

- Read and understand the Operator's Manual and all safety signs before operating, maintaining, adjusting or repairing the generator.
- Turn machine OFF, place master controls in their OFF position shut down and lock out power source, unplug power cord and wait for all moving parts to stop before servicing, adjusting, repairing or unplugging.
- Keep all electrical components tight, dry and in good repair.
- Clear the area of bystanders, especially small children.
- Replace all worn or failed components immediately with **megagen** approved parts.
- Install and secure all guards before operating.
- Keep hands, feet, hair and clothing away from moving parts.
- Review worksite. Position generator to provide electrical power accessibility and minimal interference with other equipment.
- The unit generates sufficient electrical power to injure or kill. Follow appropriate safety procedures.
- Establish a formal Lock-Out/Tag-Out program for your operation and train all operators and service personnel before allowing them work with and around the generator.
- Require all personnel to use Personal Protective Equipment (PPE) when operating or servicing the machine.
- Do not stand or climb on machine when running. Keep others off.
- Keep the working area clean and dry.
- Review safety instructions annually.

4.1 TO THE NEW OPERATOR OR OWNER

The **megagen** generator is designed to provide electrical power to areas where the power grid isn't available using a diesel engine as a power source.

It is the responsibility of the owner or operator to read this manual and to train all other operators before they start working with the machine. In addition to the design and configuration of equipment, hazard control and accident prevention are dependent upon the awareness, concern, and prudence of personnel involved in the operation, transport, maintenance and storage of equipment or in the use of facilities.

Follow all safety instructions exactly. Safety is everyone's business. By following recommended procedures, a safe working environment is provided for the operator, bystanders and the area around the worksite. Untrained operators are not qualified to operate the machine.

Many features incorporated into this machine are the result of suggestions made by customers like you. Read this manual carefully to learn how to operate the machine safely and how to set it to provide maximum efficiency. By following the operating instructions in conjunction with a good maintenance program, your **megagen** generator will provide many years of trouble-free service.

4.2 MACHINE COMPONENTS

The **megagen** generator is a diesel engine powering an alternator to generate electricity. This electricity is used to provide power to equipment or systems that require electric power in remote areas or where connecting to the grid is inconvenient, impossible or not appropriate.

The engine, radiator, muffler, fuel tank, DEF tank are all mounted inside the frame. Exhaust is direct out the top of the frame and away from the working area. Fittings are provided to attach an auxiliary fuel tank to the unit to provide longer running time between refuelling. The fuel tank is mounted under the engine and convenient to refuel. the alternator is mounted on the flywheel housing to eliminate any drivetrain components.

Batteries inside the frame provide power to start the engine. All controls and electrical connections are on the left side of the frame. Load panels are mounted in the frame to maintain an engine load factor of more than 30% to prevent wet stacking of the engine.

Five connections with breakers are available to connect to 120V, 240V, 480V and 600V with various amp loadings and single and 3 phase outputs.

A lift loop and a GPS sensor are mounted on top of the frame as a convenience to the operator when required.

Slots and a screen on each end of the frame allow air to flow through the frame to cool the engine and other components.



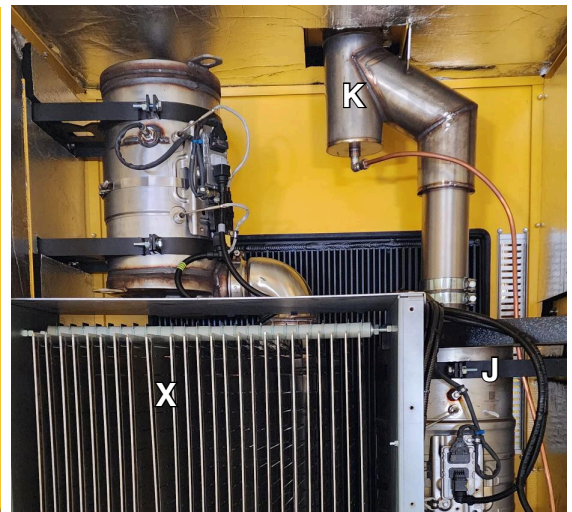
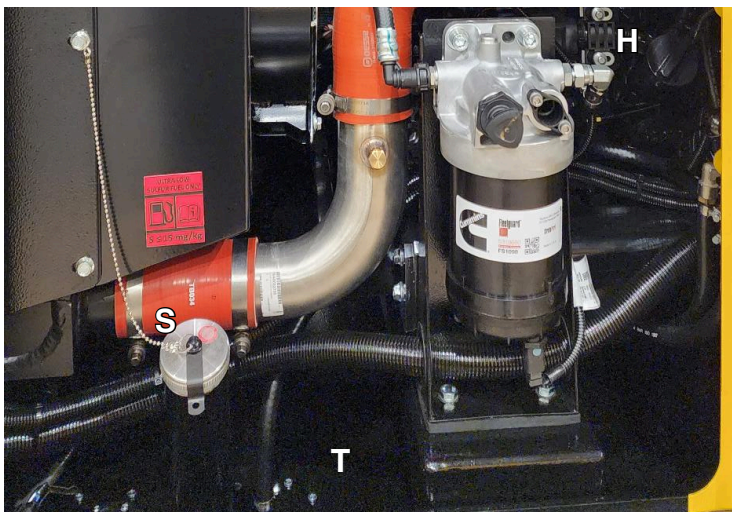
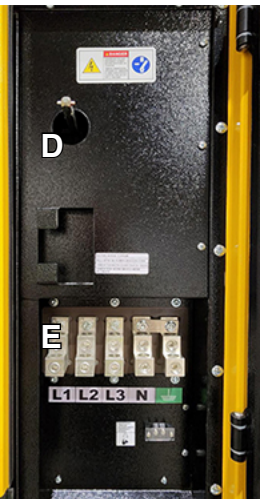
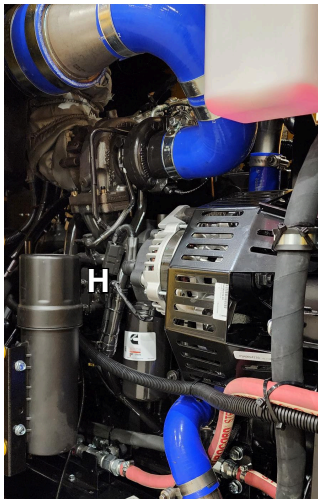

4.3 MACHINE BREAK-IN

Although there are no operational restrictions on the **megagen** generator when used for the first time, it is recommended that the following mechanical items be checked:

- A. Read all manuals before starting including generator's engine and alternator. Follow break-in procedures.
- B. **After 2, 5 and 10 hours of operation:**
 - 1. Retorque all bolts and fasteners.
 - 2. Check that all electrical connections are tight and cords are routed out of the way or protected.
 - 3. Clean air flow screens.
 - 4. Check levels in DEF tank and engine. Top up as required.
- C. **After 500 hours of operation:**
 - 1. Change the engine oil and oil filter. Replace with recommended oil.
 - 2. Then go to regularly scheduled service schedule.

4.4 PRE-OPERATION CHECKLIST

Safe and efficient operation of your new generator requires that each operator reads and follows all safety precautions and operating procedures contained in this section. Performing the following pre-operation checklist is important for personal safety as well as for continued mechanical soundness and longevity of your new **megagen** generator. The checklist should be performed before operating the generator and prior to each operation thereafter.

- Insure that proper protective gear is in good repair and available for use by each operator. Make certain that each operator uses the protective gear. Protective gear includes but, is not limited to:



- Leather gloves
 - Safety glasses or face shield
 - Full length protective clothing
 - Steel toed boots with slip resistant soles.
 - Hearing protection.
- Insure that all safety guards and shields are in good repair and securely in place.
 - Check that frame is level. Adjust as required.
 - Make sure that all electrical switches are in the OFF position before starting engine.
 - Check that all electrical connections are tight and cords are routed out of the way or protected.
 - Be sure the working area is clean and dry to prevent tripping or slipping.

4.5 CONTROLS

It is recommended that all operators read the Deep Sea Electronics module manual to learn how to operate and navigate through the module features. Knowledge and understanding of this control module allows the operator to monitor a variety of engine and machine parameters. The module is designed to control all machine functions and parameters.

1. Control Unit:

DSE 7320 MKII:

Always refer to the manual provided with the unit or refer to the unit on line for detailed instructions on setting and operation of unit.

DSE 7320 MKII is an Auto start controller that monitors the unit and indicates operational status and fault conditions. The controller can be programmed to automatically start or stop based on time schedule, fault condition or load demand.

The controller constantly monitors vital generator and engine functions for a number of pre-programmed alarm and fault conditions. When a fault condition occurs, the engine shuts down automatically and the LCD window shows the fault that caused the shutdown. To resume operation, the fault must be corrected. The controller records a history of unit performance, which may be viewed at any time and will not be lost when the controller is powered down.

2. Controller:

a. Liquid Crystal Display (LCD) Window:

Displays the various operating screens. By viewing these screens, the operator can monitor both the engine and generator status while the unit is running.

b. Menu Navigation:

Up/down and left/right triangles are used to navigate through the various operator screens. They are also used to monitor and set the various machine parameters.

c. Stop/Reset Switch:

Depress to stop or reset controller or system.

d. Manual Mode:

Depress to place the controller into its manual mode.

e. Auto Selector Switch:

Depress this switch to place the system into its auto selector mode.

f. Alarm Mute Switch:

Depress this switch to silence alarms.

g. Manual Start Switch:

Depress this switch to initiate the engine start sequence providing there are no shutdown errors and the e-stop switch is released.

h. Select Switch:

This centre switch confirms entries chosen in the various edit menus and screens.

i. Main Breaker Switch:

Depress this switch to engage main breakers.

j. Generator Breaker Control:

Depress this switch to engage generator breaker.

k. System Display:

Screen displays system parameters.

l. OFF/ON Switch:

This 2 position rotary switch turns the system control feature OFF or ON.

m. Voltage Regulation:

This rheostat is used to adjust and set the generator output voltage by a small amount or fine tune it. Turn clockwise to increase voltage and counterclockwise to decrease.

n. Load Bank Light:

This light comes on when the load bank system is connected to the load circuit to prevent wet stacking.

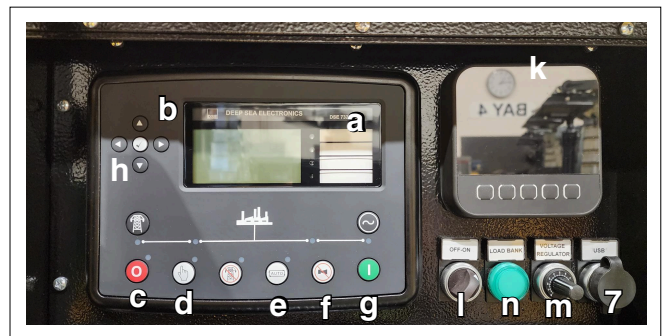

FIG. 2 DSE 7320 MKII CONTROLLER

For further information please refer to DSE 7320 MKII available on <https://www.deepseaelectronics.com/genset/lighting-tower-control-modules/dse7320-mkii>

3. **Red Emergency Stop:**

This red switch is connected to a micro switch that sends a signal to the controller to shut down the engine. Depress switch and the machine will stop. Turn the switch 1/4 turn to release the switch and it will pop out and the unit can operate. Switch must be out for unit to run. If switch was depressed due to an emergency or condition, correct condition before resuming work.

4. **AC Main Breaker:**

This 2 position switch controls the electrical power to the terminal lugs and the resistive load bank. Turn fully clockwise to turn power on and counter clockwise to turn power off.

5. **Curb Side Engine Door:**

This 2 position rotary switch controls the electrical power to the engine operating system. Turn the switch clockwise to turn the system ON and the engine will run. Turn the switch 1/4 turn counterclockwise to turn power to the engine operating system OFF. Always turn the engine system off when the unit is stopped for the day, being serviced, stored or transported.

IMPORTANT

Before turning disconnect OFF, allow 5 minutes after engine shut down to allow the DEF system to purge to prevent DEF line from fraying and bursting in cold temperatures.

6. **Power Outlet Receptacles:**

The generator is equipped with 5 convenience receptacles to provide power for customers. Each outlet is designed with a circuit breaker to prevent overloading. The 120V 20A outlets are standard 3 prong receptacles. The 120V/240V 50A receptacles are the standard twist lock receptacles.

- a. 120V 20A GFCI.
- b. 120/240V Twist Lock 50A outlet.

7. **USB Port:**

This covered USB port is provided to service personnel to use if it is necessary to access or reprogram software for any reason. Covers the port after the work is completed to prevent dirt from entering the port.

8. **Engine Block Heater:**

This covered terminal is used to provide power to the engine block heater and the battery charger. Cover the terminal when the block heater is unplugged.



FIG. 3 LEFT SIDE

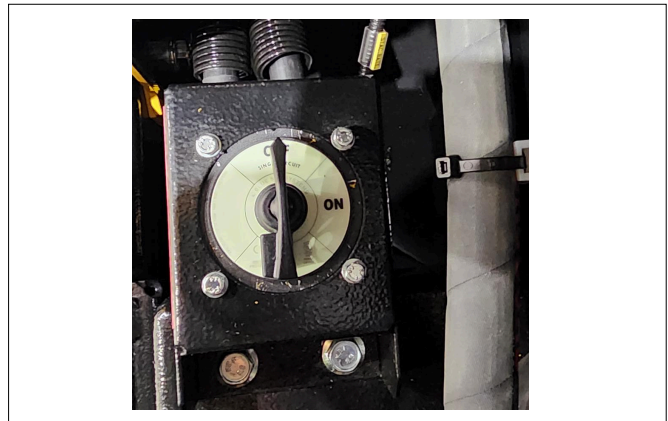

FIG. 4 MASTER ENGINE DISCONNECT

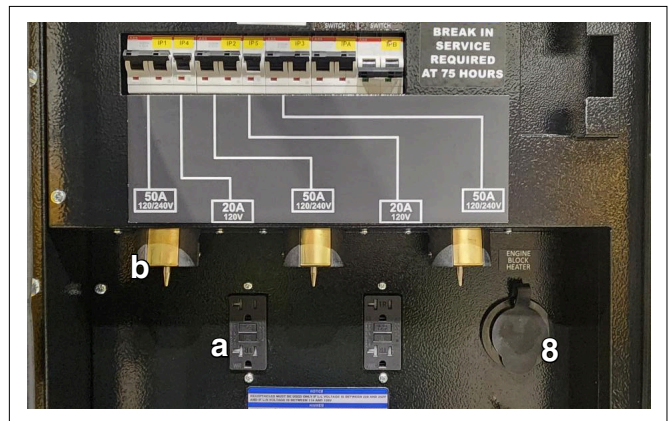

FIG. 5 OUTLETS

9. Cable Outlets:

a. L1, L2 and L3:

Circuits L1, L2 and L3 are designed to provide power to cables that are inserted from the bottom of the frame and secured with screw clamps.

b. N:

Use this connection as a ground for the 'L' circuits.

c. Ground:

This is the earth ground for the generator. Always connect this circuit to earth ground to eliminate any stray currents.

10. Rear Compartment:

a. Load Bank Switch:

This 2 position rotary switch controls the connection to the machine load bank. The switch must be turned to its On position for the load bank to be connected when the unit starts to maintain a load on the generator when it starts. Turn the switch off when the unit is stopped.

For the load bank to fully function, the Main breaker should be in the ON position to supply power to the resistive load bank.

b. Voltage Selector:

This 4 position rotary switch selects the generator output voltage and phase output. The options are:

- 347/600V 3 phase
- 277/480V 3 phase
- 208/240V 3 phase or 120/139V Single phase
- 120/240V Single phase

11. Fuel Tank Selector:

This 2 position valve selects which fuel tank will be used for the engine: internal or external. Move the handle toward the left to draw from the internal and to the right to draw from the external fuel source using the external fuel connectors.

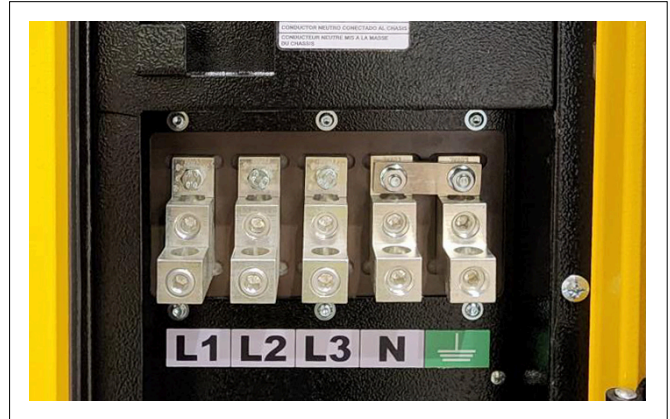

FIG. 6 CABLES



FIG. 7 SWITCHES

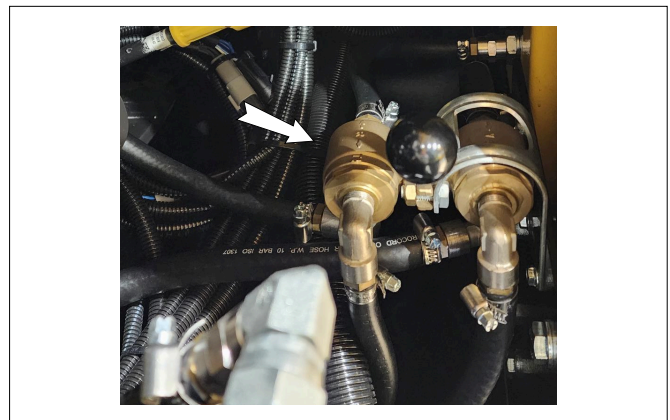



FIG. 8 FUEL TANK SELECTOR

4.6 MACHINE PREPARATION

4.6.1 MECHANICAL PREPARATION:

1. Batteries:

Batteries are an integral component in the successful operation of the generator and must be kept in top condition for the unit to perform as designed. A starter battery is provided when the unit is new and is used to start the engine

- Connect the cable to the battery terminal before starting the generator set.  
- Tighten battery pole clamp to its specified torque.
- Check the battery isolator if unit is equipped with one.
- Use rubber gloves when working with batteries as they contain sulphuric acid. Always rinse with large amounts of fresh water if contacting battery acid to prevent acid burns. It is recommended that the cable be disconnected from the battery prior to transporting the unit.

2. Engine Oil:

It is recommended that the engine oil level be checked daily to prevent running low and damaging the engine. Refer to engine operator's manual for detailed instructions and information on oil specification for varying operating environments. Do not overfill crankcase.



3. Air Filter:

Check the air filter canister when the unit is new to verify it has a filter installed. Squeeze the rubber flapper valve daily to remove any dirt that has accumulated. Open canister and remove filter if it is dirty. Shake dirt out of filter. When operating in dusty dirty conditions, it may be necessary to clean the filter every few days. Replace filter after it has been cleaned 4 or 5 times. Do not overclean. Removing and installing the filter can damage seals. Damaged seals can allow dust to enter the engine and damage it.

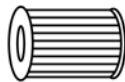

4. Diesel Fuel:

Check the fuel level every day to prevent running out. Since the unit can run for 38 to 42 hours without refuelling under ideal conditions, the low fuel level alarm will sound on the display at 18% and the machine will shut down at 10%.

Turn engine off before refuelling.

Do not smoke when refuelling and keep all sparks and burning material away. Refuel outside or in a well ventilated environment. Do not spill fuel. Clean it up before starting. Refer to engine manual for details on types of fuel to use in various temperature environments. Do not overfill tank. Leave 10 mm (1/2 inch) of space between level of fuel and top of tank to allow for fuel expansion. Use winter diesel or add special additives to fuel when operating in cold temperatures.



5. Antifreeze/Coolant:

When the engine is new, it is filled with an anti-freeze solution that is rated to -40° C. The anti-freeze prevents both interior corrosion and protection against freezing. To maintain this protection, do not mix different types of antifreeze. Refer to engine operator's manual to determine the specifications of the approved antifreeze.

If the cooling system requires servicing, do not remove radiator cap when the engine is running or is still hot as the coolant could spill out abruptly and cause serious burns. Remove cap slowly and carefully. Always maintain the integrity of the coolant overflow tank. It receives the excess coolant as the system heats up and expands. It provides coolant into the radiator as the system cools and contracts.



4.6.2 HANDLING:

The machine is designed with features that allow it to be easily and conveniently moved, positioned and transported.

Three features are available to assist in handling:

1. **Lifting with hoist:**

A bracket on the top of the machine is positioned at the machine centre of gravity. This allows for a hoist to raise the unit without the frame tilting. Attach the hook on the hoist to the centre slot for the best results.

Always use the hand grip when attaching hoist.

2. **Forklifts:**

The frame is designed with 2 lateral pockets extending across the frame for lifting the machine. Push the forks completely through the frame until they extend out the other side to keep the machine level and even when lifted. Raise slowly and raise only as high as required.

3. **Tie Downs:**

The frame is designed with slots on the bottom of the frame for use to secure to the frame when transporting on a trailer. Do not attach to any other place to tie down unit when transporting.



FIG. 9 LIFTING

4.6.3 ELECTRICAL PREPARATION:

Every operator should review the operator's manuals from the engine, Deep Sea Electronics and alternator manufacturers provided in the document package. Follow the detailed instructions in each manual:

Connect the neutral point of the generator set to the machine ground. By using the TN or TT distribution system. The differential switch guarantee protection against indirect contact. If complex systems are connected to the machine which require or use additional electrical protective devices you must check the coordination between the protective devices. Use the prepared terminal to earth. Comply with local and/or current regulations on installation and electrical safety.

4.6.4 POSITIONING:

Machine positioning and placement are important to the functioning and reliability of the generator.

When positioning machine. follow this procedure:

1. Review the worksite and select an area where the machine is out of the way and not interfere with the other equipment on the worksite and yet provide power to the required area.
2. Tow the machine to the selected spot (Refer to Transport Section) if mounted on a trailer.
3. Unhook from the tow vehicle.
4. Use a crane on hoist to lift generator off transport vehicle and place on ground.



FIG. 10 GROUND TERMINAL



FIG. 11 POSITIONED (TYPICAL)

4.6.5 DSE 7320 MK11

The machine is designed with the DSEWebNet Gate-way system used in conjunction with supported DSE controllers to provide monitoring and communication via the DSEWebNet advanced communication system. The DSEWebNet Gateway communicates to a maximum of 5 DSE controller(s) monitoring the instrumentation and operating state.

When this data changes, the new data is logged in the internal memory. At regular intervals the logged data is transmitted to the DSE hosted server. The DSE hosted server is then integrated into the DSEWeb-Net® which can be accessed via an internet connected device and web browser to allow remote monitoring and control of multiple DSE controllers worldwide. GSM, GPS and combined GSM & GPS Antenna's are available as standard on your Z120/Z150 generator.

You can easily download installation instruction from: <https://www.deepseaelectronics.com/genset/remote-communications-overview-displays/dse7320>

4.6.6 AUTOMATIC LOAD BANK

The unit is powered by a diesel engine. Diesel engines are susceptible to wet stacking if lightly loaded. Wet stacking can occur when an engine is run at less than 30% of its full load capacity, causing unburned fuel to accumulate in the engine. Wet stacking can be detected by continuous black exhaust from the muffler when the unit is under a constant load. It can also cause fouling of injectors and buildup on engine valves. Diesel engines operate properly when applied loads are between 30% and 100% of system capacity. Our Z120/Z150 generator is equipped with an automatic load bank in order to avoid wet stacking. Load bank will start automatically after a few seconds. It will keep running when engine load factor is less than 30%. Once another load is connected, the load bank will automatically turn OFF.

For the load bank to function properly, the main breaker needs to be in the ON position. When the load bank turns on the green indication light next to the control panel will illuminate.

Load bank is functional only in 120/240V single phase and 208/240V 3 Phase.

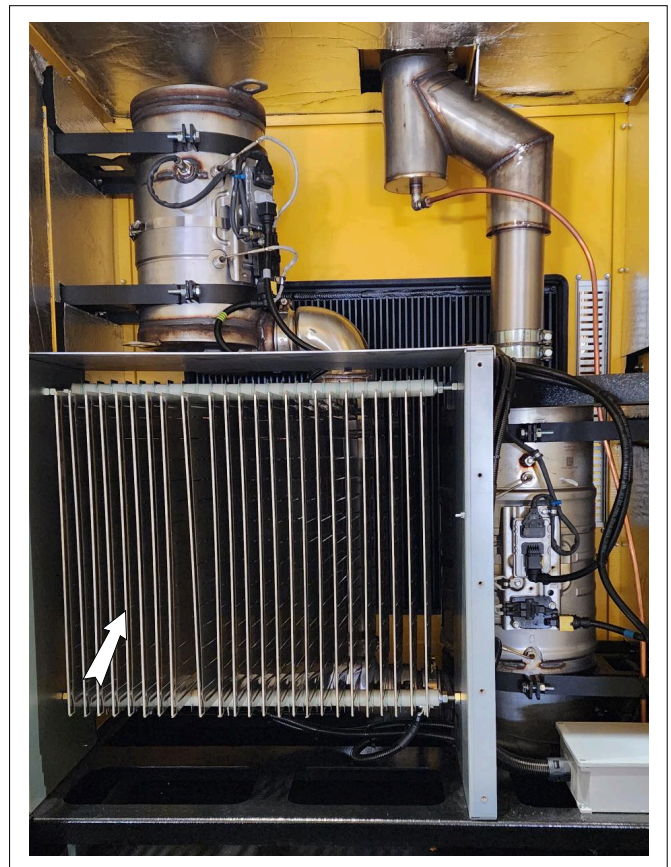

FIG. 12 LOAD BANK

4.7 OPERATION



OPERATING SAFETY

- Read and understand the Operator's Manual and all safety signs before operating, maintaining, adjusting or repairing the generator.
- Turn machine OFF, place master controls in their OFF position shut down and lock out power source, unplug power cord and wait for all moving parts to stop before servicing, adjusting, repairing or unplugging.
- Keep all electrical components tight, dry and in good repair.
- Clear the area of bystanders, especially small children.
- Replace all worn or failed components immediately with **megagen** approved parts.
- Install and secure all guards before operating.
- Keep hands, feet, hair and clothing away from moving parts.
- Review worksite. Position generator to provide electrical power accessibility and minimal interference with other equipment.
- The unit generates sufficient electrical power to injure or kill. Follow appropriate safety procedures.
- Establish a formal Lock-Out/Tag-Out program for your operation and train all operators and service personnel before allowing them work with and around the generator.
- Require all personnel to use Personal Protective Equipment (PPE) when operating or servicing the machine.
- Do not stand or climb on machine when running. Keep others off.
- Keep the working area clean and dry.
- Review safety instructions annually.

Follow this procedure when using the generator:

1. Move unit to work site and unhook or unload (refer to Transport Section).
2. Chock the wheels if mounted on trailer.
3. Review Section 4.6 Machine Preparation and follow all the instructions.
3. Review and follow the pre-operation checklist (See Section 4.4).
4. Review the location and function of all controls (See Section 4.5).



FIG. 13 MACHINE (TYPICAL)

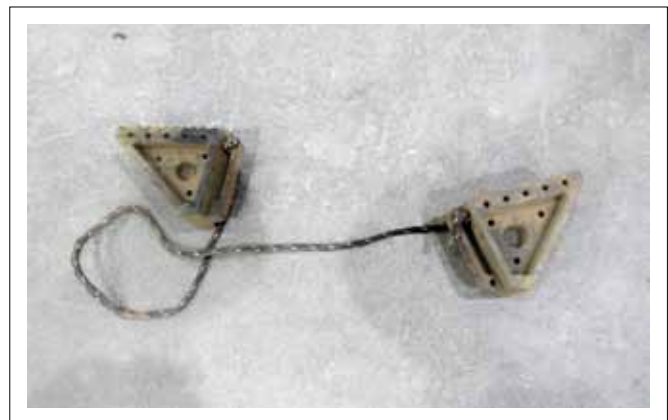

FIG. 14 CHOCKS (TYPICAL)

5. **Starting Steps:**

- a. Refer to and follow the machine preparation and set-up sections. Be sure machine is located on a firm, level base.
- b. Release the red e-stop switch by turning it 1/4 turn.
- c. Turn the battery isolator switch ON.



FIG. 15 MASTER POWER SWITCH

- d. Use the selector switch to select the voltage and phase of the generator output desired.

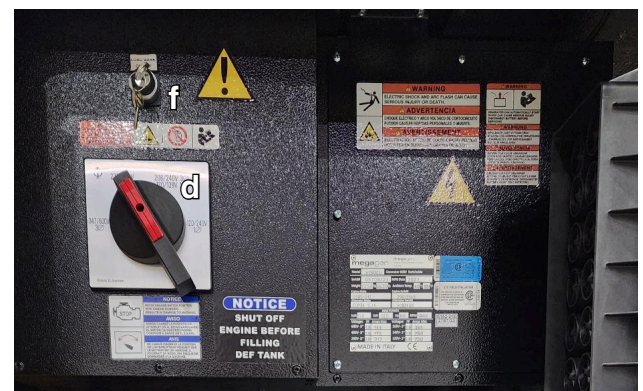

Compartment



Voltage Selector Switch

- e. Review the terminal connection specifications and select the appropriate terminal.
- f. Turn the key switch on.

TERMINAL CONNECTIONS / BORNES DE CONEXION		RACCORDS TERMINALS	
	Φ 277/480V 3Ø 100 kVA 90 A	L1-N: 347V L2-N: 347V L3-N: 347V L1-L2: 600V L2-L3: 600V L1-L3: 600V	
	Φ 277/480V 3Ø MAX 88 kVA 245 A	L1-N: 120V L2-N: 120V L3-N: 120V L1-L2: 208V L2-L3: 208V L1-L3: 208V	
	Φ 277/480V 3Ø MAX 100 kVA 120 A	L1-N: 277V L2-N: 277V L3-N: 277V L1-L2: 480V L2-L3: 480V L1-L3: 480V	
	Φ 277/480V 3Ø MAX 41 kVA 171 A	L1-L3: 240V L1-N: 120V L2-N: / L3-N: 120V	

Output Specs

FIG. 16 OUTPUT SELECTORS

- g. Depress the white switch with the finger to set system into manual mode.

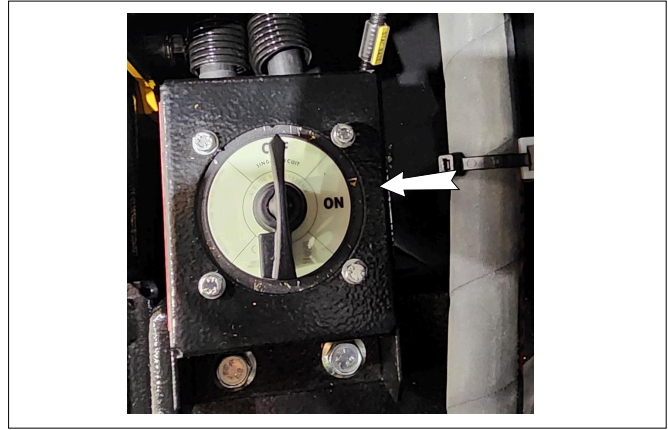

FIG. 17 ISOLATOR SWITCH

- h. Depress the green engine start switch to initiate the engine start sequence.
- i. Wait until the engine stabilizes.
- j. Set voltage with potentiometer to desired voltage.



Controls

- k. If external load is less than 30%, the load bank will set in and the load bank light will come ON.

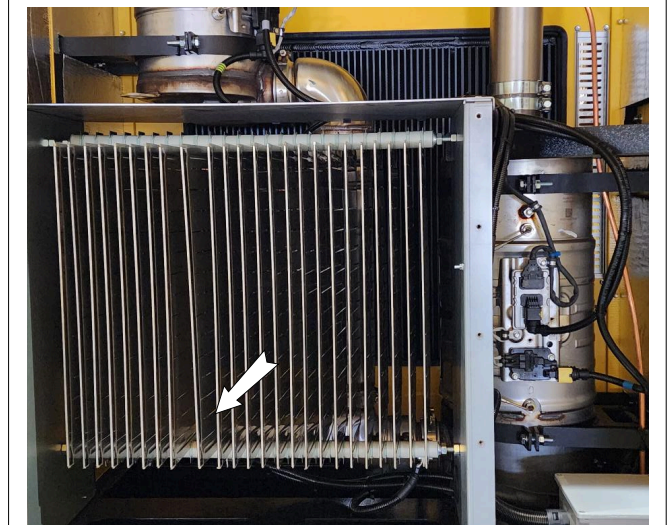

Load Bank

FIG. 18 NO LOAD

11. Fuel Tank Selector:

The generator is designed with an internal fuel tank that comes from the factory and is plumbed into the engine. In addition a set of fuel connections are provided on the left side of the frame that allow the operator to connect an auxiliary tank to provide longer operating time between refuelling. Use the handle on the selector valve as an indicator on which tank is being used:

- a. Selector valve - Internal.
- b. Selector valve - External.
- c. Auxiliary tank couplers.

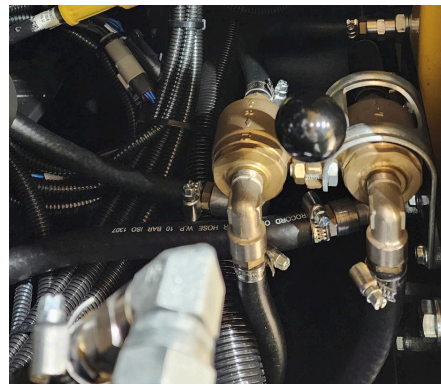

Selector Valve - External



Selector Valve - Internal



Auxiliary Tank Couplers

FIG. 19 FUEL SYSTEM

11. Operating Hints:

- a. The machine is designed to generate a large amount of electrical power that can injure, maim and kill if not handled with care.
 - Always stop engine, place all controls in their off position and wait for all moving parts to stop before servicing, maintaining, adjusting or cleaning machine.
 - Always use Personal protective Equipment (PPE) when operating or servicing machine.
- b. Keep the area around the machine clean and free from clutter to prevent ripping or slipping.

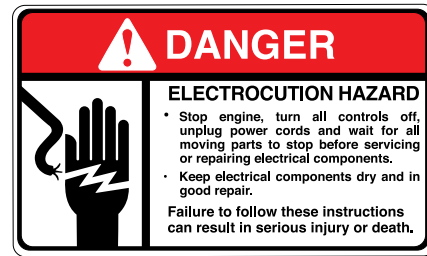

FIG. 20 CLEAN WORKING AREA

- c. Always attach doors to latch anchor behind the door when it has been opened to prevent closing from a gust of wind.

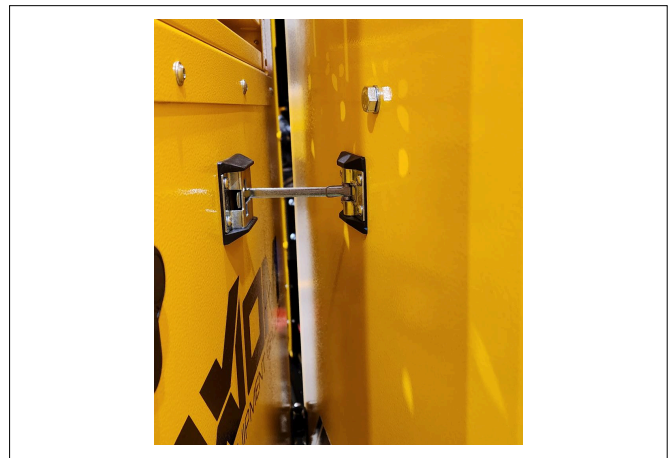

FIG. 21 DOOR LATCH

4.8 STORAGE



STORAGE SAFETY

- Store the generator on a firm level surface.
- If required, make sure the unit is firmly blocked up.
- Make certain that all mechanical locks and jacks are safely and positively connected before storing.
- Store away from areas of human activity.
- Do not allow children to play on or around the stored generator.
- Lock out power by turning off master control panel or junction box and padlocking the door shut to prevent electrocution or unauthorized start up of the generator.
- If mounted on a trailer, place chocks in front of and behind the tires before unhooking from tow vehicles.

4.8.1 PLACING IN STORAGE

At the end of the season, the machine should be thoroughly inspected and prepared for storage. Repair or replace any worn or damaged components to prevent any unnecessary down time at the beginning of the next season. Follow this procedure:

- Start the engine and run for 10 minutes to bring the oil to operating temperature. Change the oil and oil filter. Replace the engine oil as specified in the Maintenance Section.
- Thoroughly wash the outside of the machine using a pressure washer to remove all dirt, mud, debris or residue.
- Do not wash the inside of the machine to prevent getting water into the alternator and electrical circuits.
- If stored on an **megagen** trailer, lower hitch jack and secure.
- Place chocks in front of and behind wheels if mounted on trailer.
- Press the red switch on the DSE controller to turn engine OFF.
- Turn main battery disconnect OFF.
- Touch up all paint nicks and scratches to prevent rusting.
- Select a storage area that is dry, level and free of debris.

4.8.2 REMOVING FROM STORAGE

When preparing to use the machine at the start of the season, follow this procedure:

- Transport or move to the working area.
- Check
 - a. Engine fluid levels.
 - b. Electrical systems and components.
 - c. All hardware. Tighten as required.
 - e. Air pressure in tires. Add as required.
- Replace any defective components.
- Go through the pre-operation checklist (section 4.4) before starting.



FIG. 22 STORED

4.9 TRANSPORT



TRANSPORT SAFETY

- Make certain that you are in compliance with local, state/provincial and federal regulations regarding transporting equipment on public roadways.
- Make certain that all wheels and tires are in good repair and that tires are inflated to proper pressure. Do not under-inflate or over-inflate.
- Make certain that all wheel bolts/lug nuts are tightened to proper torque specifications (refer to specification chart in Section 7.2).
- Secure and lock access doors before transporting.
- Raise jack into its fully UP position and secure with lock pin.
- Do not park generator on a steep slope.
- Be sure that any necessary signs, reflectors and lights required by law are in proper place and are clearly visible to oncoming and overtaking traffic.
- Be sure that the generator is positively hitched to the towing vehicle. Use a safety cable to assure a safe hitch hook-up when transporting.
- Use a 3/4 ton pickup or larger truck to tow machine.
- Do not allow anyone to ride on the generator during transport.
- Clear the area of obstacles and unnecessary personnel.
- Do not place any objects or loads on the frame to prevent changing the center of gravity or overloading the frame.
- Do not exceed a safe travel speed of 90 km/55mph with trailer. Slow down for corners and rough surface conditions.

megagen Z120 and Z150 generators are designed and equipped to be towed on public roadways when mounted on an **megagen** trailer by vehicles with sufficient weight and braking capability. If not mounted on trailer, they must be loaded on a transport trailer and hauled.

Prepare the unit by:

- Press the red switch on the DSE controller to turn engine OFF and turn key switch OFF.
- Turn main battery disconnect OFF.
- Remove any cords plugged into the machine.
- Hook up to tow unit.
 - a. Align hitches while backing up to hitch.
 - b. Connect pintle or ball hitch.
 - c. Secure hitch with retainer to prevent unexpected separation.

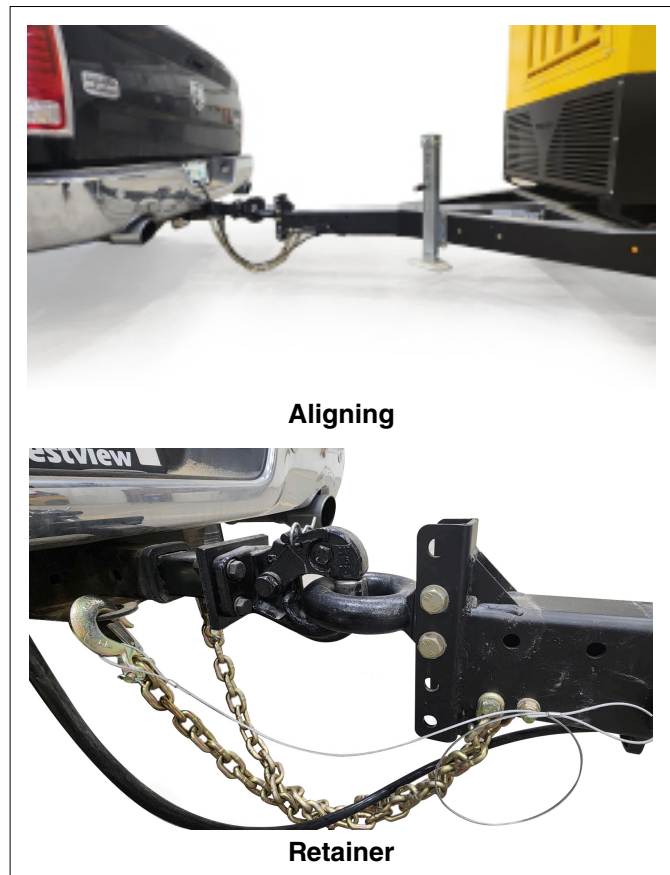

FIG. 23 PINTLE HITCH

- d. Attach safety chains while crossing them under the hitch.



Safety Chain - Attached

- e. Attach wiring harness terminal.



Wiring Harness - Connected

- f. Raise the hitch jack into its fully UP position.
g. Rotate jack and pin in its horizontal position.
h. Secure jack handle with its retainer.
i. Reverse this procedure when unhooking.



Jack Rotated/Handle Secured

- Check that all required lights are clean and no bulbs are burned out.
- Do not drink or use drugs and drive.
- Do not allow riders on machine.
- Do not exceed a safe travel speed. Slow down for corners or rough surfaces.



Hooked Up

FIG. 24 TRANSPORTING

5 SERVICE AND MAINTENANCE



MAINTENANCE SAFETY

- Read and understand all the information contained in the Operator's Manual regarding operating, servicing, adjusting, maintaining and repairing.
- **Turn machine OFF, shut down and lock out power supply and wait for all moving parts to stop before servicing, adjusting, maintaining or repairing.**
- Follow good shop practices:
 - Keep service area clean and dry.
 - Be sure electrical outlets and tools are properly grounded.
 - Use adequate light for the job at hand.
- Make sure all guards and doors are in place and properly secured when operating the generator.
- Do not work on generator electrical system unless the power cord is unplugged or the power supply is locked out. Lock-out tag-out power source before performing any maintenance work.
- A fire extinguisher and first aid kit should be kept readily accessible while performing maintenance on this equipment.
- Disconnect load from power supply and wait for all moving parts to stop before performing any service or maintenance or work on them.
- Do not touch engine, manifold, pipes and muffler while engine is running. Allow engine to cool before performing any service work on it.
- Always replace guards and shields and close doors when service and repair work has been completed.
- Do not remove radiator cap when engine is running or still hot to prevent leaks and scalding burns.

5.1 SERVICE

5.1.1 FLUIDS AND LUBRICANTS

1. **Grease:**
Use an SAE multipurpose high temperature grease with extreme pressure (EP) performance. Also acceptable is an SAE multipurpose lithium base grease.
2. **Engine Oil:**
Refer to engine manual for oil specifications to use with this engine. Consult the engine manual for unusual operating conditions. Do not mix oil types or viscosities.

Refer to engine manual for oil specifications
3. **Diesel Fuel:**
Refer to engine manual for fuel specifications. Special fuel and additives required for cold ambients.
4. **Storing Lubricants:**
Your machine can operate at top efficiency only if clean lubricants are used. Use clean containers to handle all lubricants. Store them in an area protected from dust, moisture and other contaminants.

5.1.2 SERVICING INTERVALS

8 Hours or Daily

1. Check engine fluid levels:
 - a. Fuel
 - b. Crankcase oil
 - c. Coolant

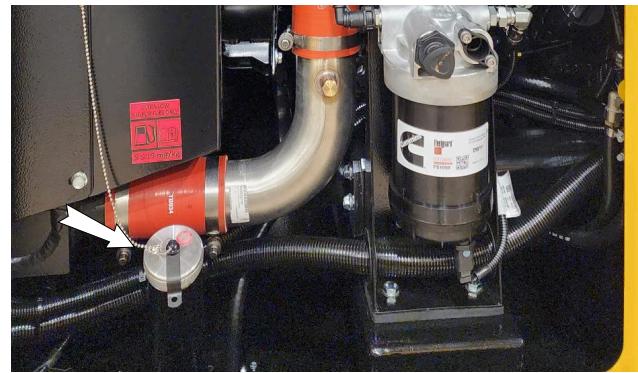

Fuel Cap

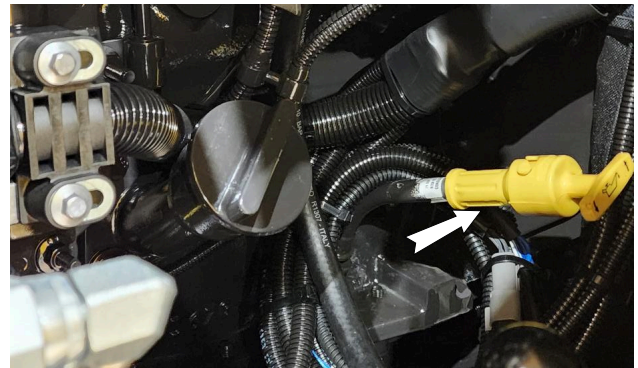

Dipstick

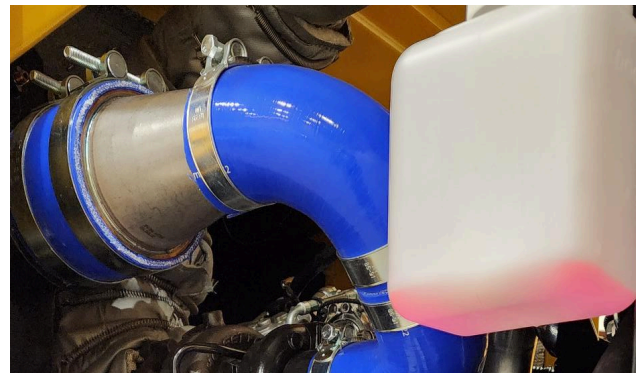

Coolant

FIG. 25 FLUID LEVELS

2. Check DEF tank fluid level.

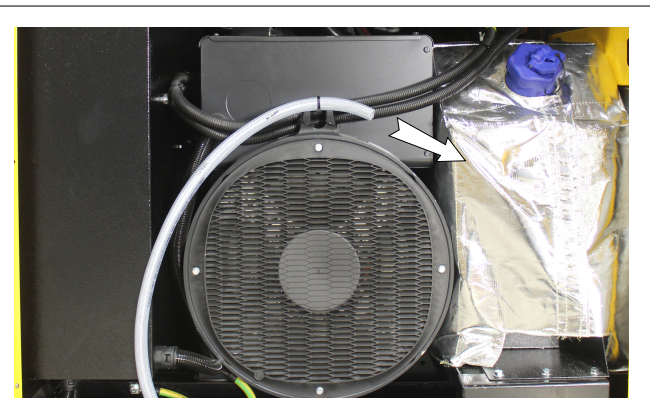

FIG. 26 DEF TANK

3. Remove dust from air cleaner flapper.

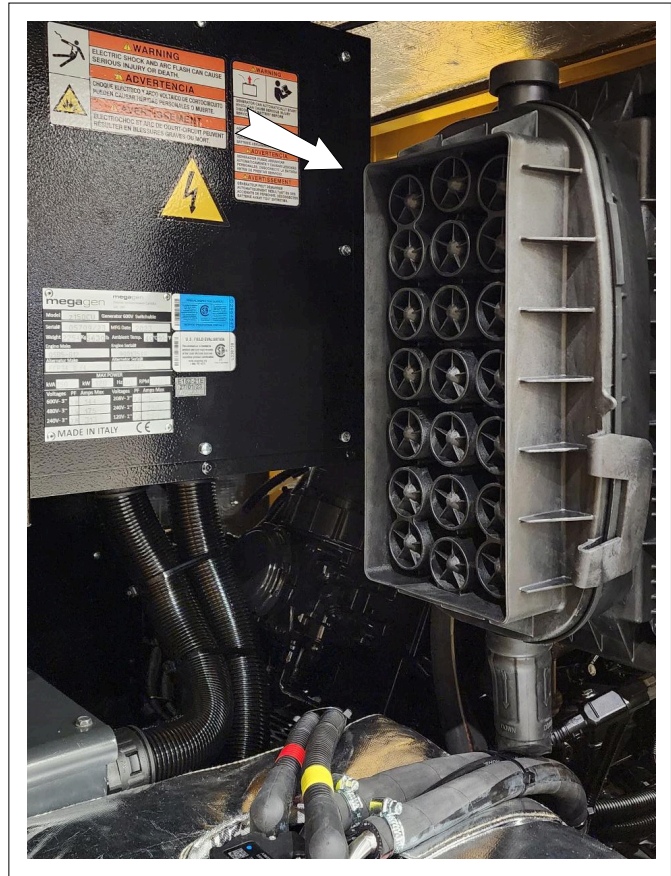

FIG. 27 AIR CLEANER

4. Clean air louvers.



FIG. 28 SCREENS

100 Hours

1. Change break-in engine oil and oil filter. This service item only must be done once when unit is new. Then service every 500 hours. Follow the service schedule outlined in the engine manufacturer's manual.

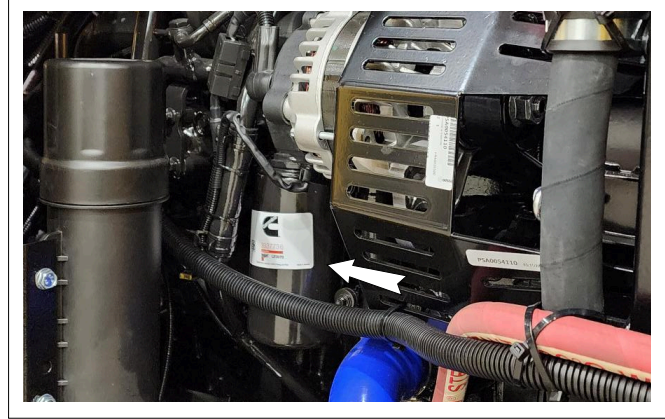

FIG. 29 OIL FILTER

As Required

1. Remove the air cleaner filter and shake it out. Replace filter after cleaning 5 times.

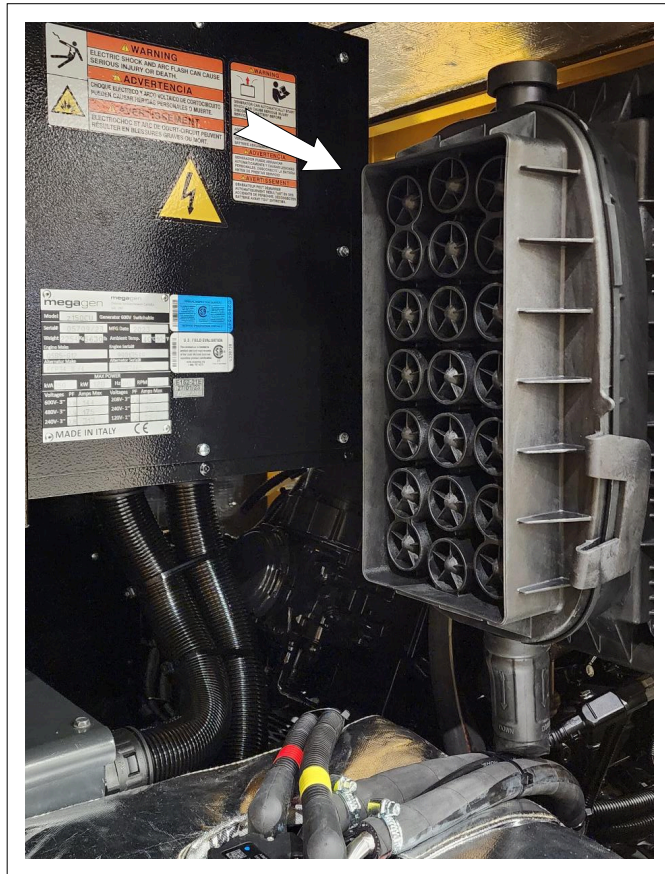

FIG. 30 AIR CLEANER (TYPICAL)

500 Hours or Annually

1. Change fuel filter.
 - a. Engine oil.
 - b. Oil filter.
 - c. Fuel filter.
 - d. Air filter.

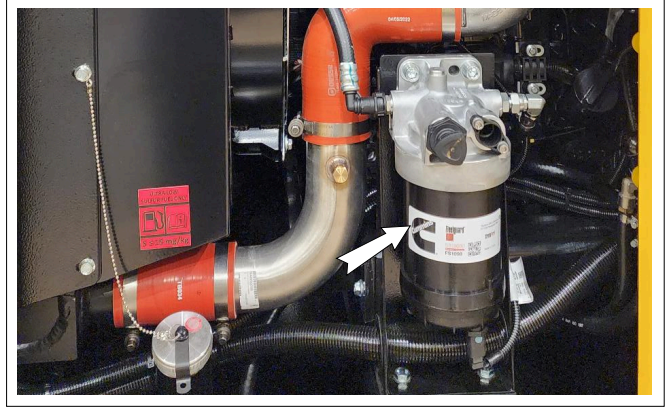

FIG. 31 FUEL FILTER

2. Clean machine.

IMPORTANT

Never pressure wash near the alternator end as it may cause electrocution or catastrophic failure of major components.



FIG. 32 CLEAN MACHINE

5.2 MAINTENANCE

The machine is designed to generate electricity for use at any location for any purpose. By following a careful service and maintenance program on your machine, you will enjoy many years of trouble-free use.

5.2.1 ELECTRIC SYSTEM INSPECTION

The machine is designed to generate electricity for use at any location for any purpose. By following a careful service and maintenance program on your machine, you will enjoy many years of trouble-free use.

To maintain the integrity of each system and provide a safe working environment for the operator, it is important that a daily inspection be done to make sure that all systems and components are in good working condition.

When inspecting the electrical system and components, follow this procedure:

1. Place all controls in the OFF or neutral position.
2. Turn master electric switch OFF and lockout before starting the inspection.
3. Inspect all electrical components looking for:
 - a. Damaged receptacle.
 - b. Frayed or loose wires.
 - c. Cut or cracked insulation.
4. Replace any damaged components immediately.
5. Be sure all components are grounded.
6. Be sure there is not water or moisture in any junction box or enclosure. Dry the components before turning power on. Be sure that all compartments seal properly when closed.

5.2.2 CLEANING AIR CLEANER

1. Review the operator's manual for the engine.
2. Place all controls in the OFF or neutral position.
3. Turn OFF battery disconnect.
4. Open engine door.
5. Remove cover over air cleaner.
6. Remove the filter from the air cleaner.
7. Use a damp cloth to remove any dust and debris from the filter housing. Shake the dust and dirt out of the filter.
8. Install filter.
9. Install and secure cover.
10. Close and secure engine door.

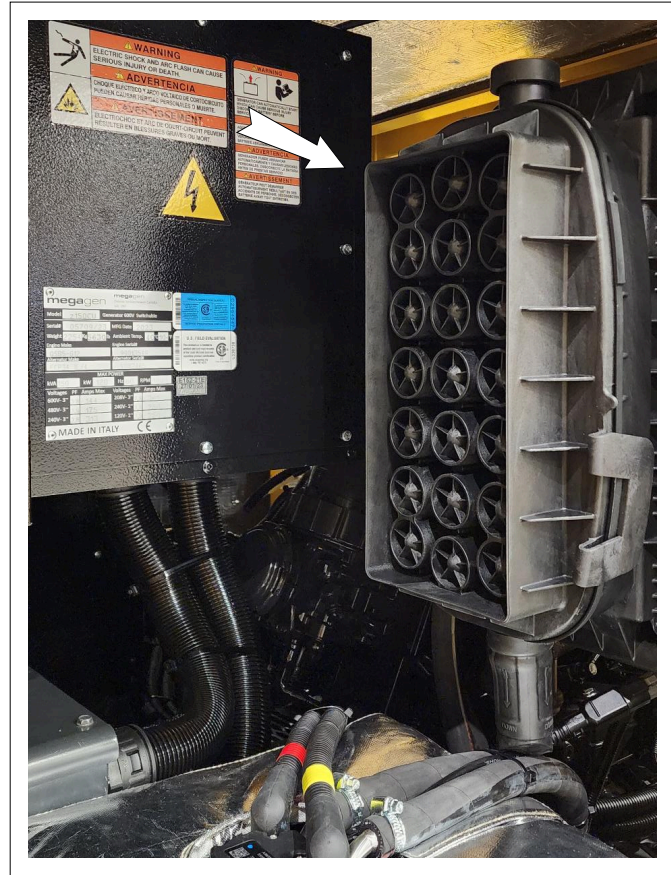

FIG. 33 AIR CLEANER

5.2.3 CHANGING ENGINE OIL AND FILTER

1. Review the operator's manual for the engine.
2. Place all controls in the OFF or neutral position.
3. Turn OFF battery disconnect.
4. Open engine door.
5. Allow the engine to cool before changing the oil. Hot oil can cause burns if it contacts exposed skin. It is best to change oil while the engine is warm to keep any contaminants in suspension.
6. Place a pan under the oil discharge hose.
7. Open drain valve and let drain until all oil is drained.
8. Remove the engine oil filter.
9. Apply a light coat of oil to the 'O' ring and install the replacement filter. Snug up by hand and then tighten to correct torque.
10. Close the drain valve and secure the drain hose.
11. Dispose of the used oil in an approved container at a disposal site.
12. Fill the crankcase with specified oil.
13. Run the engine for 1 - 2 minutes and check for oil leaks.
14. If leaks are found around the drain plug or filter, tighten slightly.
15. Check engine oil level. Top up as required.
16. Close and secure engine access door.

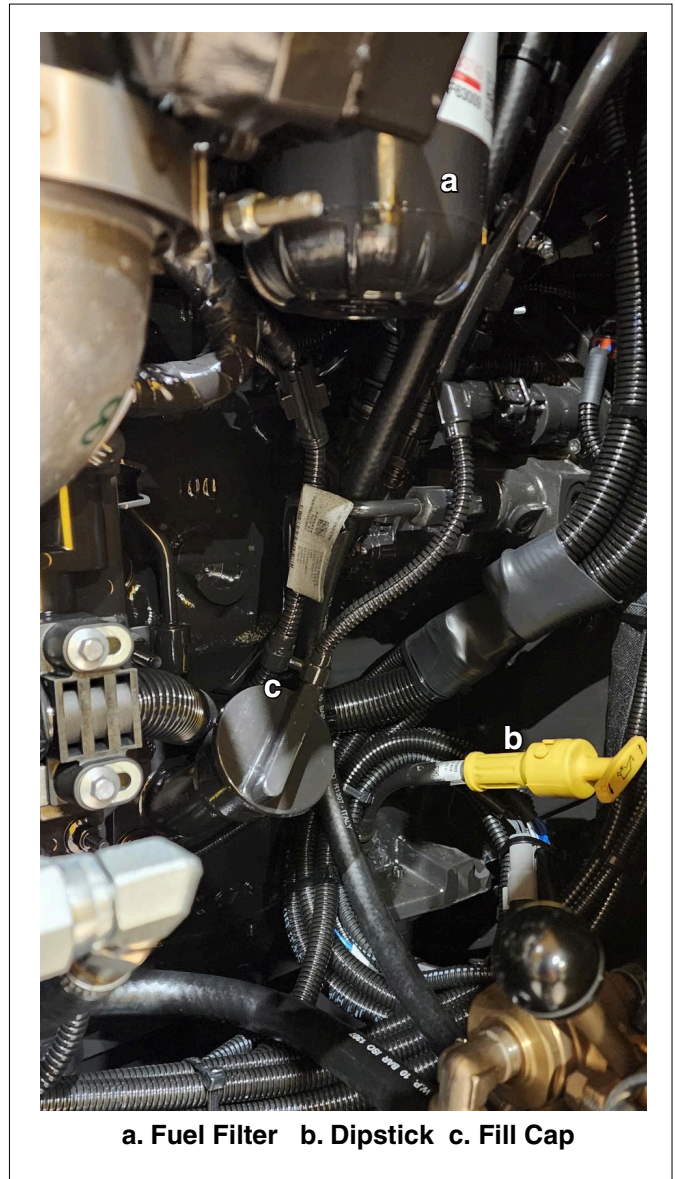

FIG. 34 ENGINE

5.2.4 CHANGING ENGINE FUEL FILTER AND WATER TRAP SCREEN FILTER

1. Review the operator's manual for the engine.
2. Place all controls in the OFF or neutral position.
3. Turn OFF battery disconnect.
4. Open engine door.
5. Allow the engine to cool before changing the fuel filter. Hot fuel can cause burns if it contacts exposed skin.
6. Place a pan under the fuel filter.
7. Loosen the hose clamps and remove fuel hoses from screen filter.
8. Remove and replace screen filter.
9. Fit fuel hoses to screen filter and tighten hose clamps.
10. To replace water trap fuel filter, disconnect water trap sensor.
11. Loosen filter.
12. Drain fuel from filter into a container.
13. Dispose of fuel in an environmentally safe manner.
14. Remove water trap sensor from old filter.
15. Remove old O-ring and fit new one on sensor.
16. Install water trap sensor onto new filter.

IMPORTANT

NEVER PRE-FILL fuel/water trap before installation as this may cause damage to the fuel injection system. Prime fuel filter using the prime valve on the fuel filter housing until pressure is felt on the prime button/pump.

17. Check engine fuel level. Top up as required.
18. Close and secure engine access door.

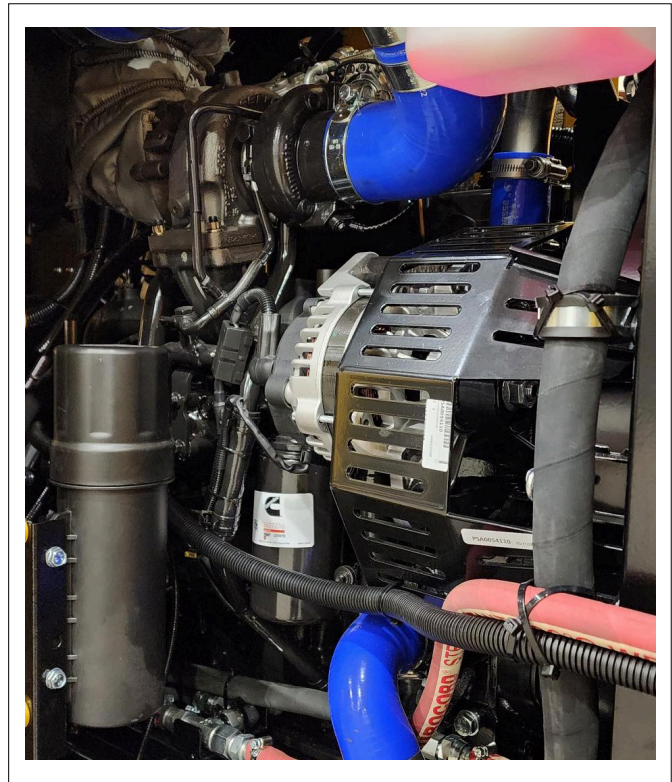

FIG. 35 ENGINE

6 TROUBLE SHOOTING

The **megagen** Z120/Z150 generator is a machine with an alternator and controls to generate single or 3 phase power at 4 different power levels. A diesel engine provides power to generate electricity.

In the following section, we have listed many of the problems, causes and solutions to the problems that you may encounter.

If you encounter a problem that is difficult to solve, even after having read through this trouble shooting section, please contact your local **megagen** dealer or the factory. Before you call, please have this Operator's Manual from your machine ready.

PROBLEM	CAUSE	SOLUTION
Engine won't start.	Low battery.	Charge battery.
	Emergency STOP switch engaged.	Release STOP switch.
Start and stop (engine).	No fuel.	Fill fuel tank. Bleed fuel lines.
	Clogged fuel filter.	Replace fuel filter.
	Fuel circuit failure.	Check fuel lines.
No generator output.	Main circuit breaker open.	Close main circuit breaker.
	Voltage regulator malfunction.	Call megagen Equipment group for service.
Low oil pressure.	Low oil level.	Fill engine sump with oil.
	Clogged oil filter.	Replace oil filter.
	Oil pump failure.	Call megagen Equipment group for service.
High coolant temperature.	Electrical overload.	Reduce load.
	Low coolant level.	Fill with coolant.
	Low oil level.	Fill sump with oil.
	Clogged oil filter.	Call megagen Equipment group for service.

7 SPECIFICATIONS

7.1 MECHANICAL

The Z120/Z150 is a portable generator that can provide electrical power at any location. Please see data sheet below and dimensional specifications as well.

SPECIFICATIONS		Z120	Z150
Dimensions (L x W x H) (Skid)	in	117.9 x 45 x 73.8	117.9 x 45 x 73.8
Operating Weight (Skid)	lbs	6867	6945
Prime Output	kW (kVA)	96 (120)	120 (150)
Voltage	V	240 / 480 / 600	240 / 480 / 600
Frequency	Hz	60	60
Sound Level	dB(A)	70	70
Battery	V	12	24
Receptacles		(2) 120V 20A (3) 120V / 240V 50A	(2) 120V 20A (3) 120V / 240V 50A
Engine		Cummins QSB4.5	Cummins QSB4.5
Emissions		T4F	T4F
Fuel Type		Diesel	Diesel
Tank Capacity	gal (L)	187.5 (710)	187.5 (710)
Fuel Consumption Per Hour*	gal/H (L/H)	5.3 (20)	6.3 (24)
Urea Tank Capacity	gal (L)	15 (57)	15 (57)
Urea Consumption	gal/H (L/H)	0.24 (0.9)	0.28 (1.08)
Runtime*	hr	35.5	29.6
Gen End		Mecc Alte	Mecc Alte
Trailer Mount Option		Yes	Yes
Secondary Fluid Containment		110%	110%

*At 75% load

SPECIFICATIONS SUBJECT TO CHANGE WITHOUT NOTICE

7.2 BOLT TORQUE

CHECKING BOLT TORQUE

The tables shown below give correct torque values for various bolts and capscrews. Tighten all bolts to the torques specified in chart unless otherwise noted. Check tightness of bolts periodically, using bolt torque chart as a guide. Replace hardware with the same strength bolt.

ENGLISH TORQUE SPECIFICATIONS

Bolt Diameter "A"	Bolt Torque*					
	SAE 2 (N.m) (lb-ft)		SAE 5 (N.m) (lb-ft)		SAE 8 (N.m) (lb-ft)	
1/4"	8	6	12	9	17	12
5/16"	13	10	25	19	36	27
3/8"	27	20	45	33	63	45
7/16"	41	30	72	53	100	75
1/2"	61	45	110	80	155	115
9/16"	95	60	155	115	220	165
5/8"	128	95	215	160	305	220
3/4"	225	165	390	290	540	400
7/8"	230	170	570	420	880	650
1"	345	225	850	630	1320	970

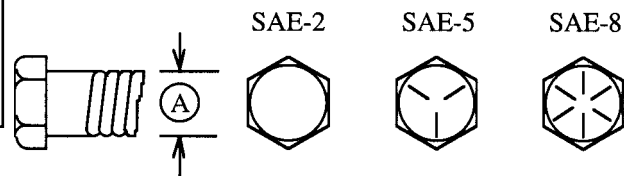

METRIC TORQUE SPECIFICATIONS

Bolt Diameter "A"	Bolt Torque*			
	8.8 (N.m) (lb-ft)		10.9 (N.m) (lb-ft)	
M3	.5	.4	1.8	1.3
M4	3	2.2	4.5	3.3
M5	6	4	9	7
M6	10	7	15	11
M8	25	18	35	26
M10	50	37	70	52
M12	90	66	125	92
M14	140	103	200	148
M16	225	166	310	229
M20	435	321	610	450
M24	750	553	1050	774
M30	1495	1103	575	1550
M36	2600	1917	3675	2710

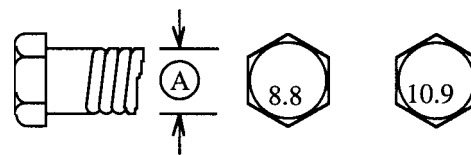

Torque figures indicated above are valid for non-greased or non-oiled threads and heads unless otherwise specified. Therefore, do not grease or oil bolts or capscrews unless otherwise specified in this manual. When using locking elements, increase torque values by 5%.

* Torque value for bolts and capscrews are identified by their head markings.

7.3 ELECTRICAL SCHEMATIC

1. Power Part

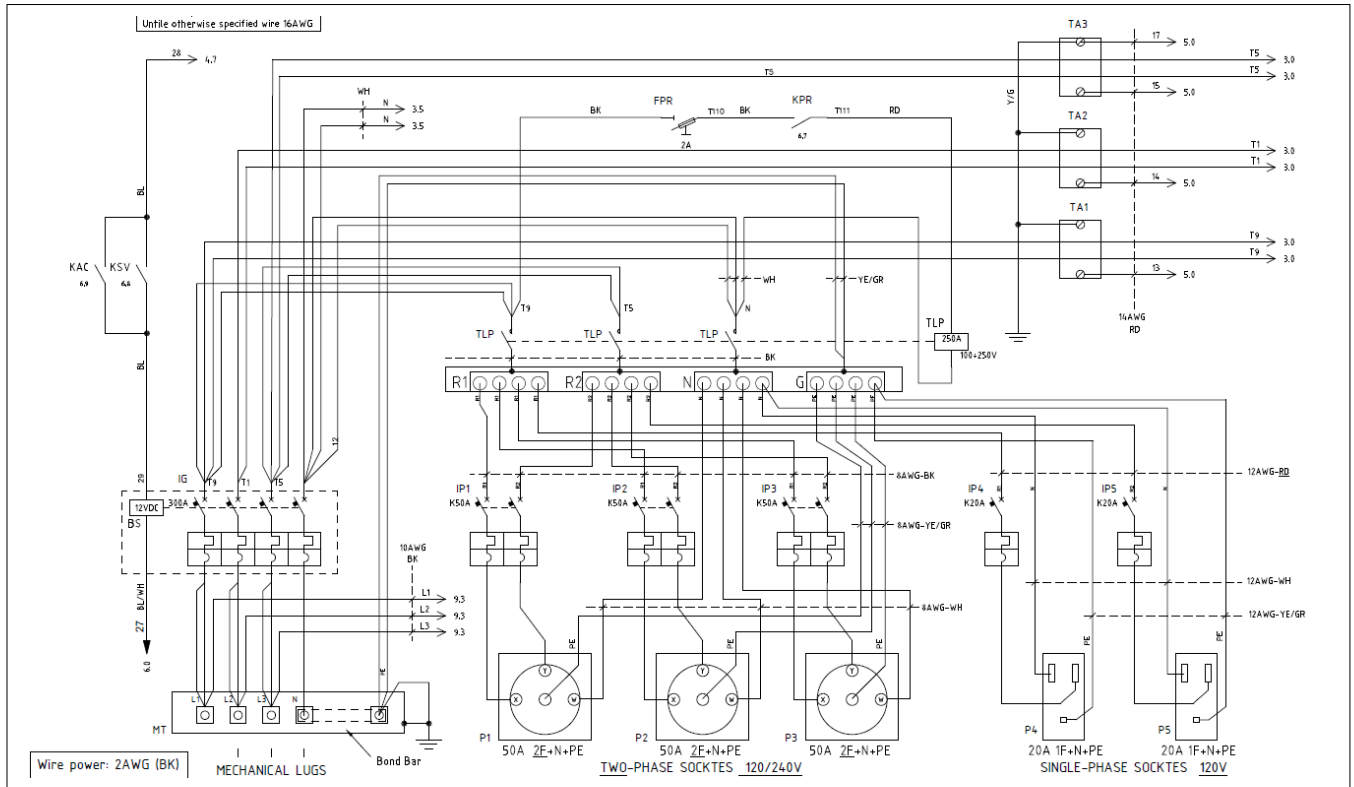

2. Power Switch

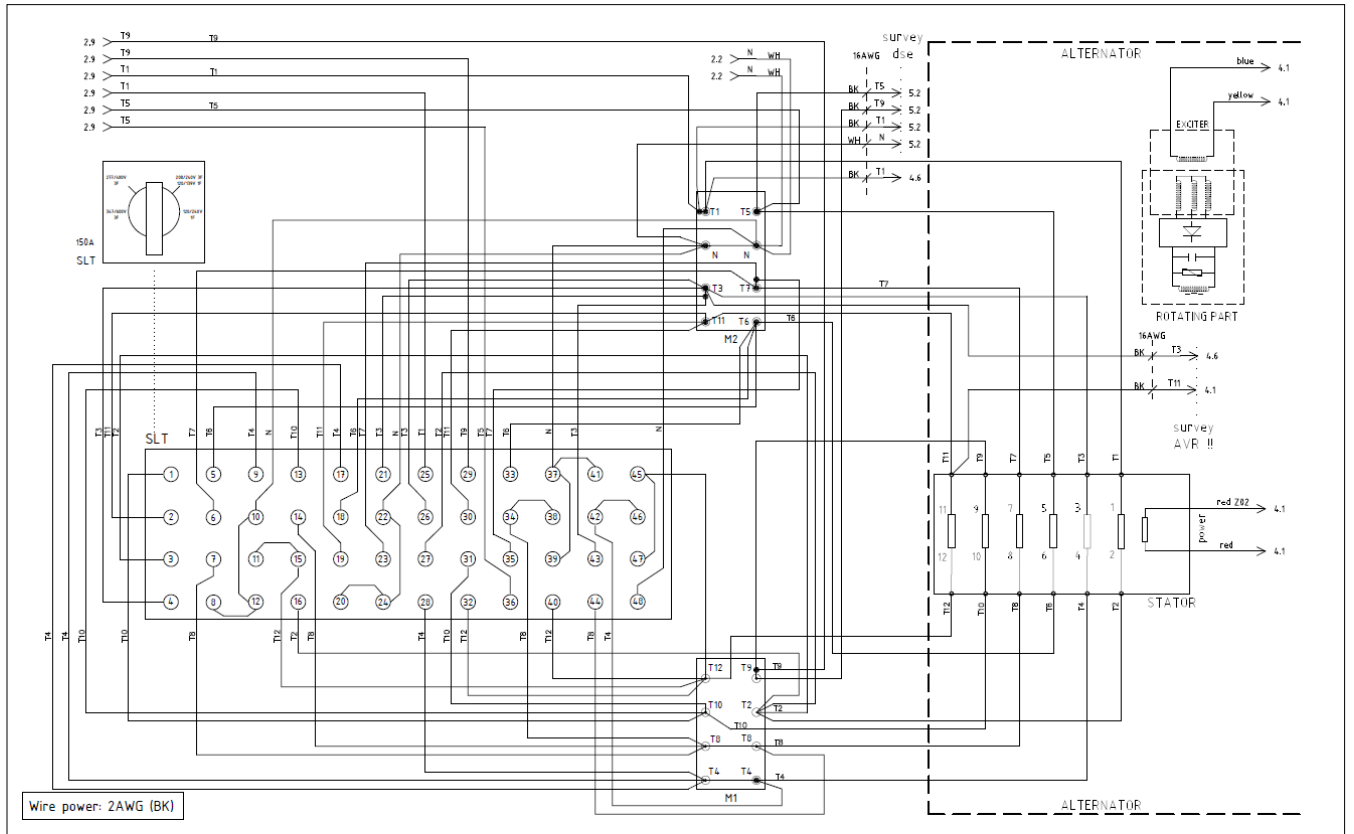

3. Voltage Regulator

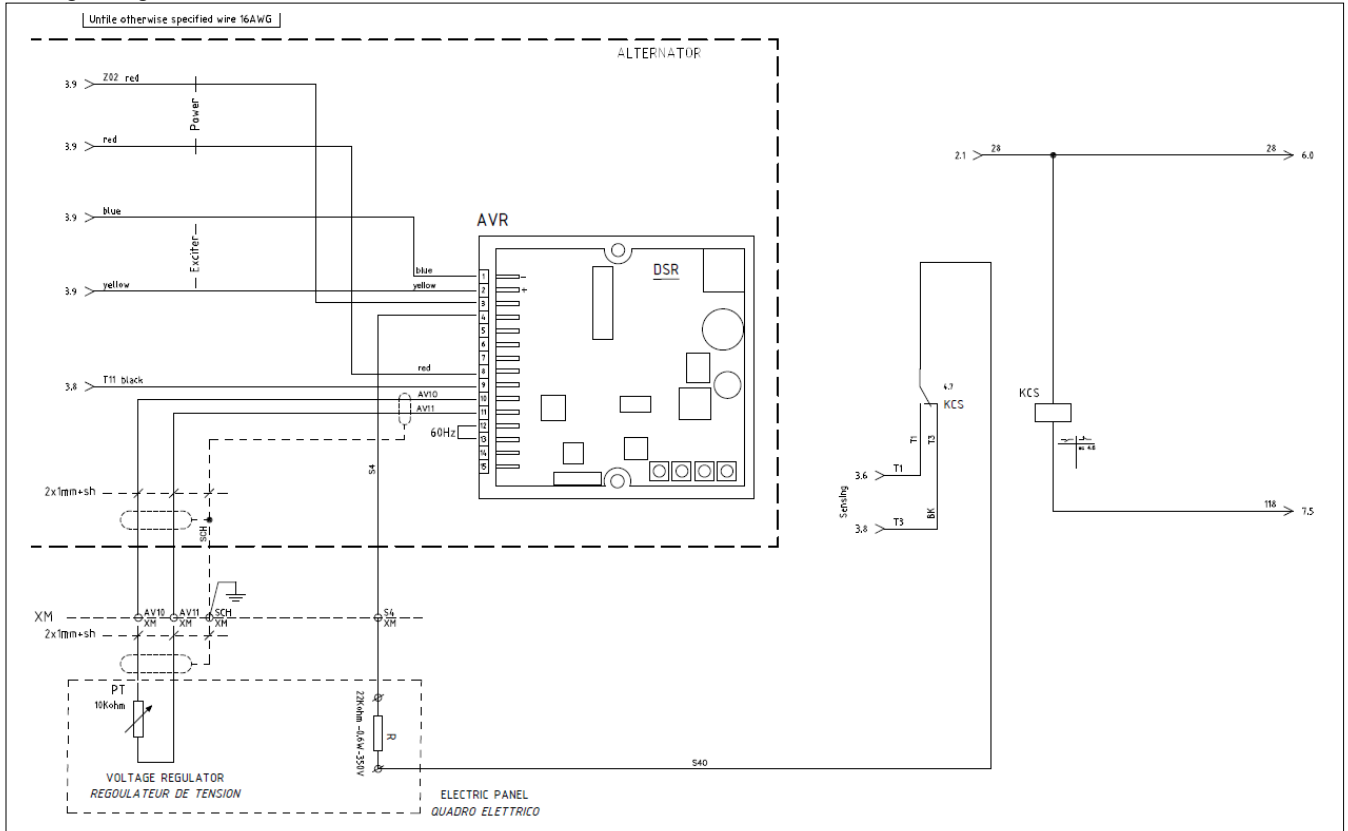

4. Electronic Card Survey

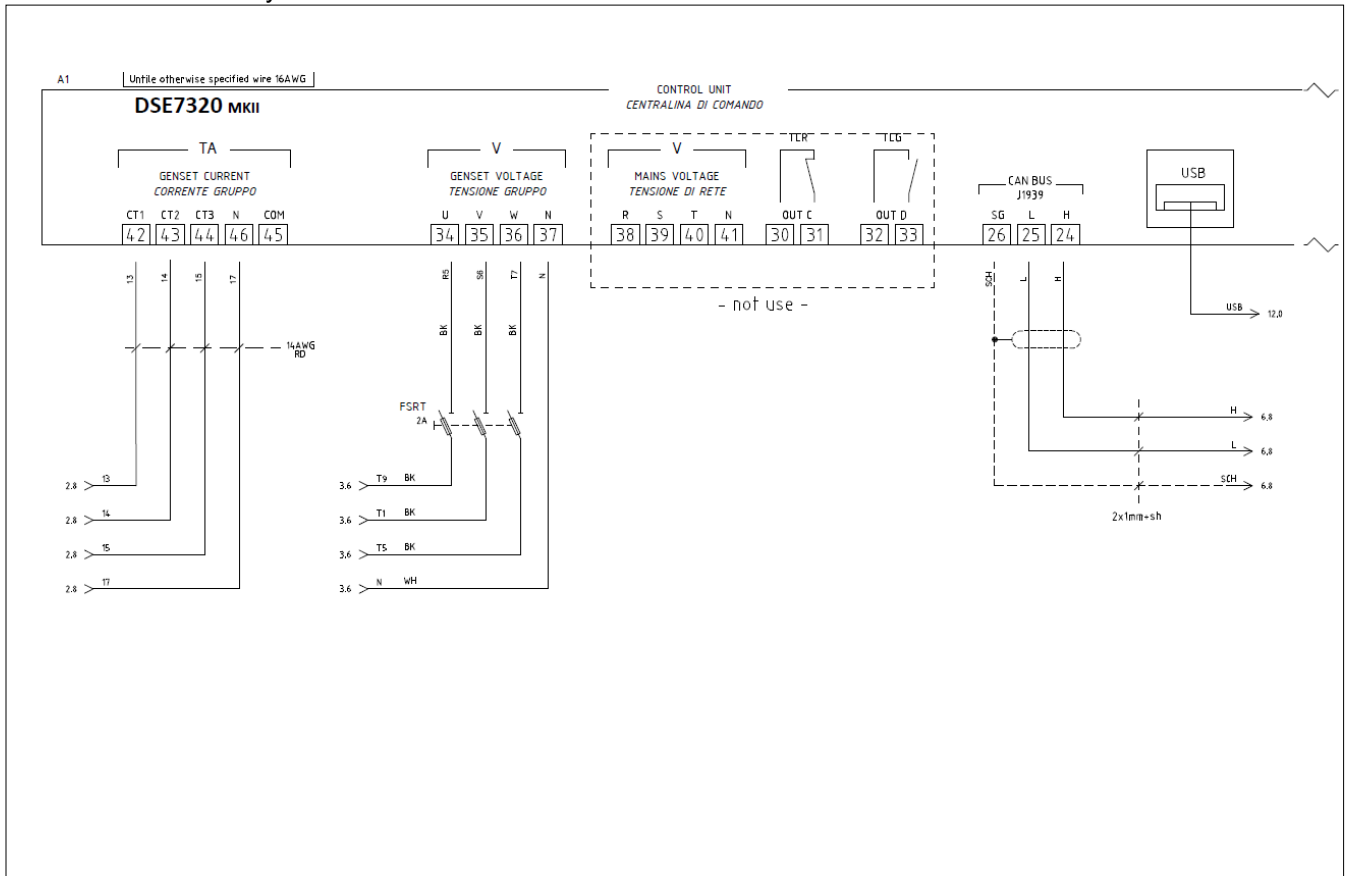

7. Digital Inputs

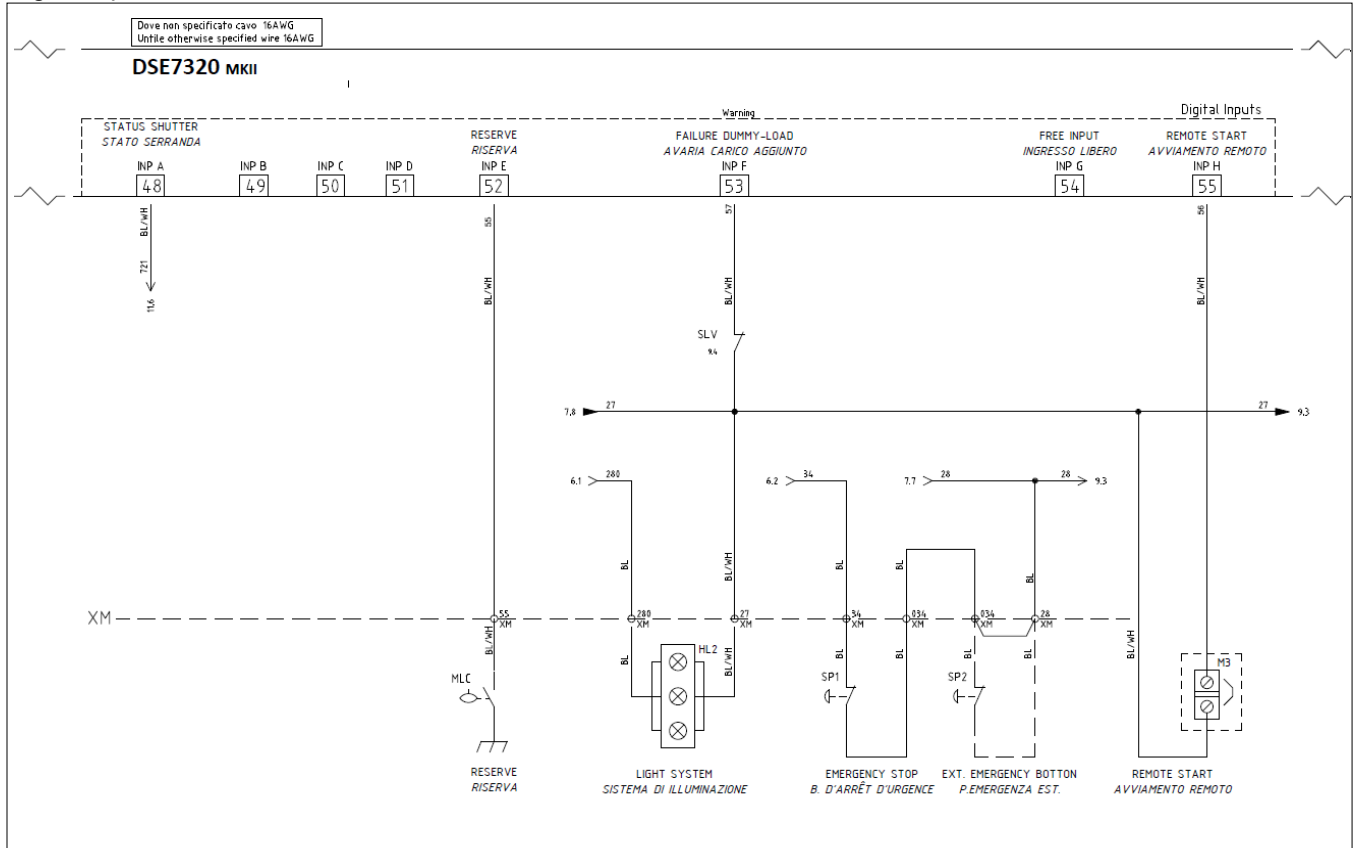

8. Dummy Load

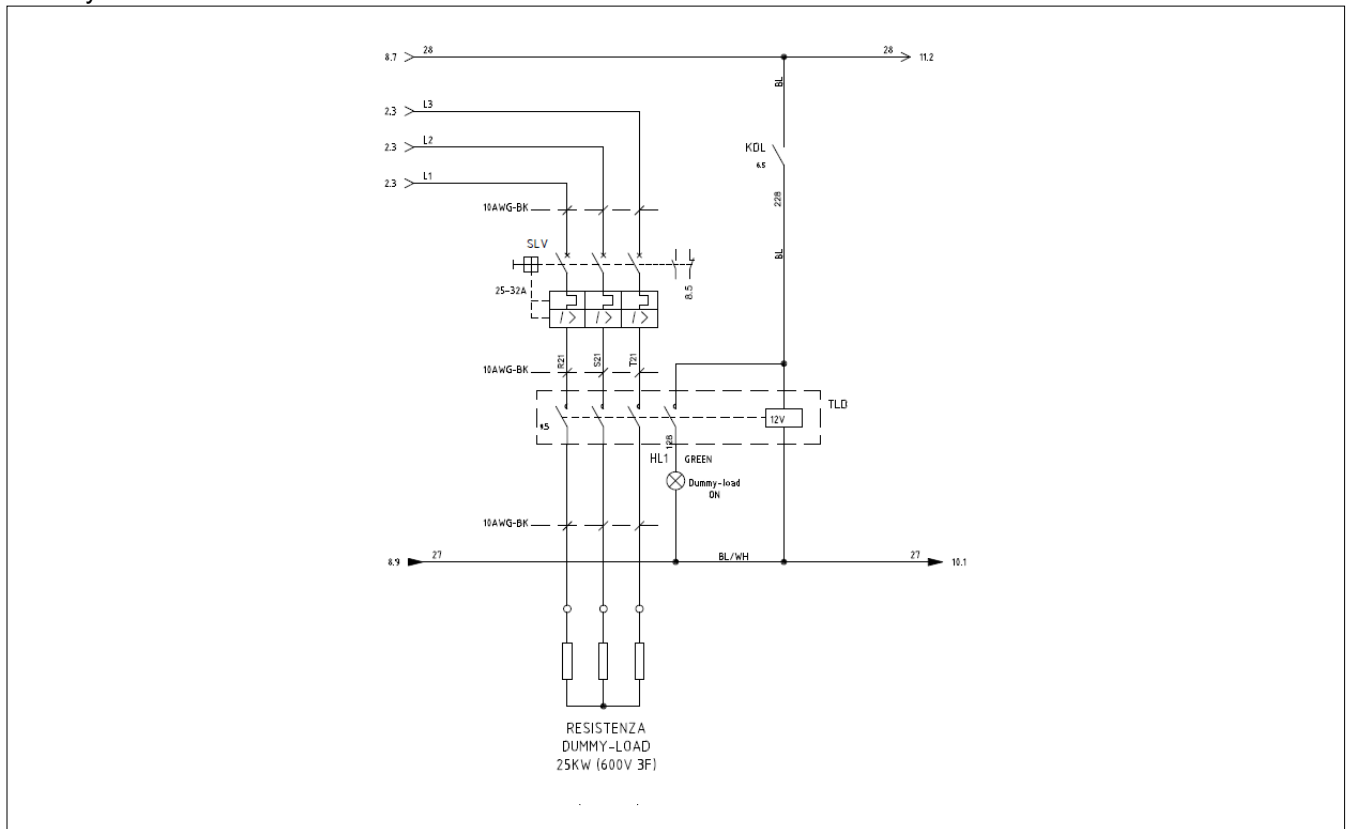

9. Auxiliary

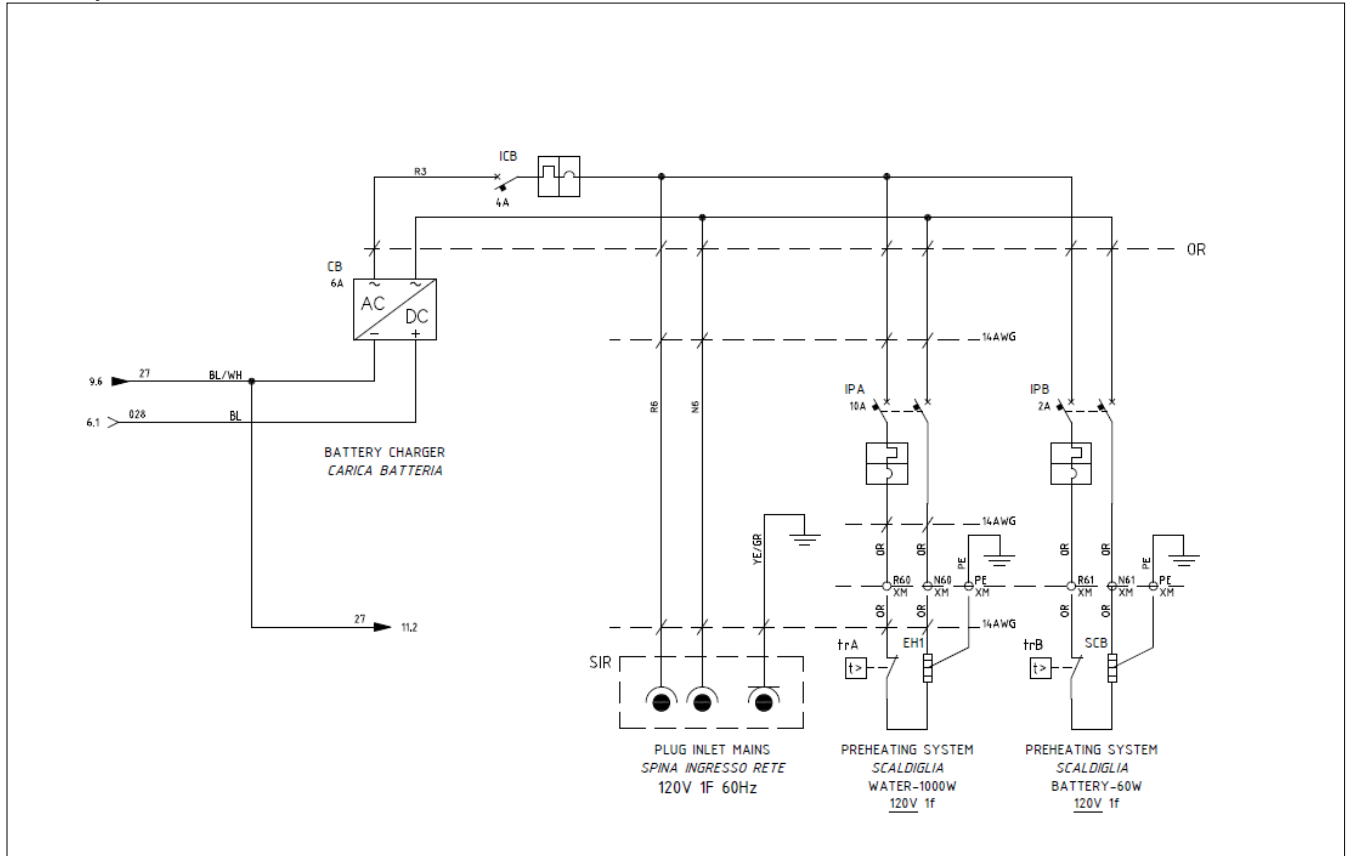

10. Shutters

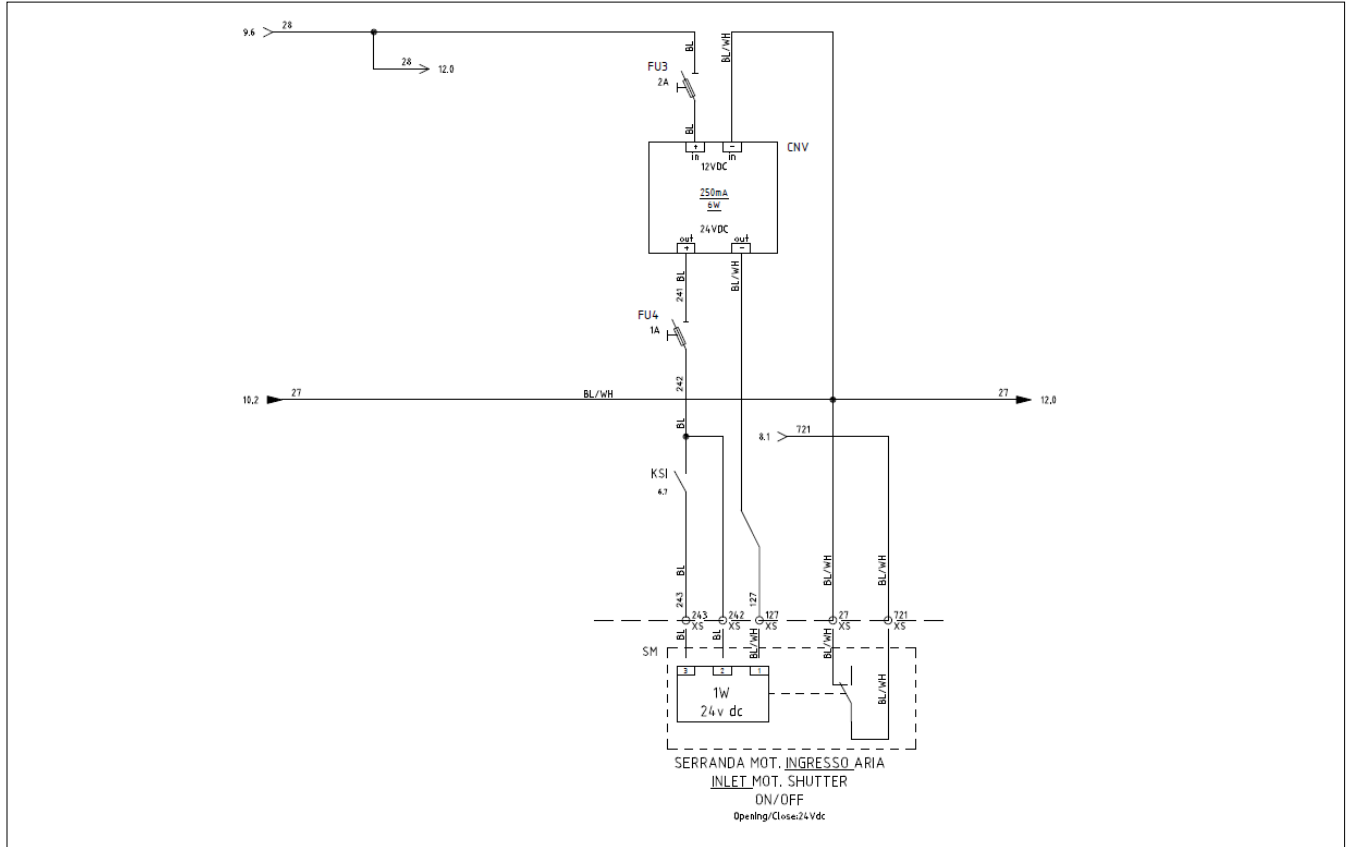

11. Modules

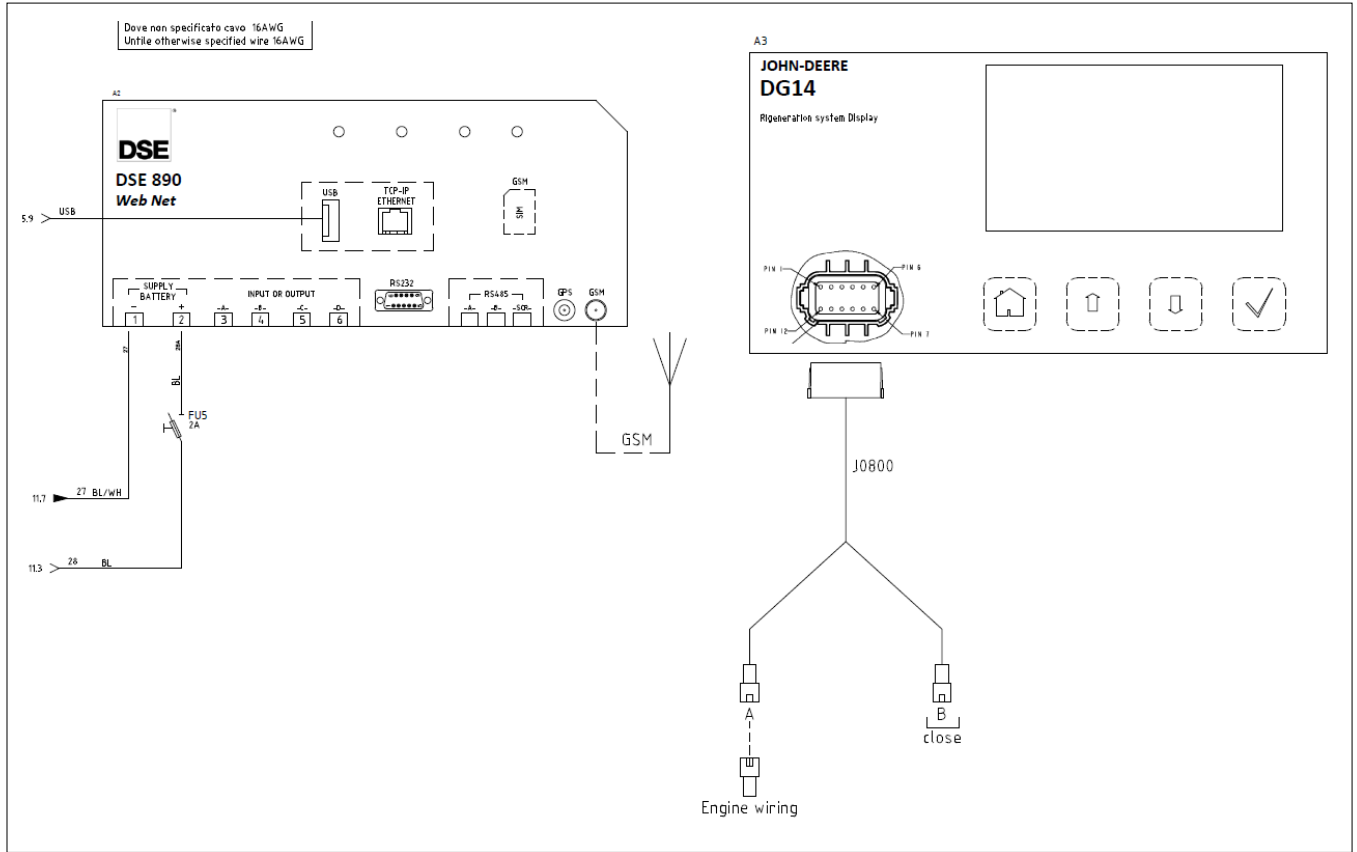

12. Terminal Board

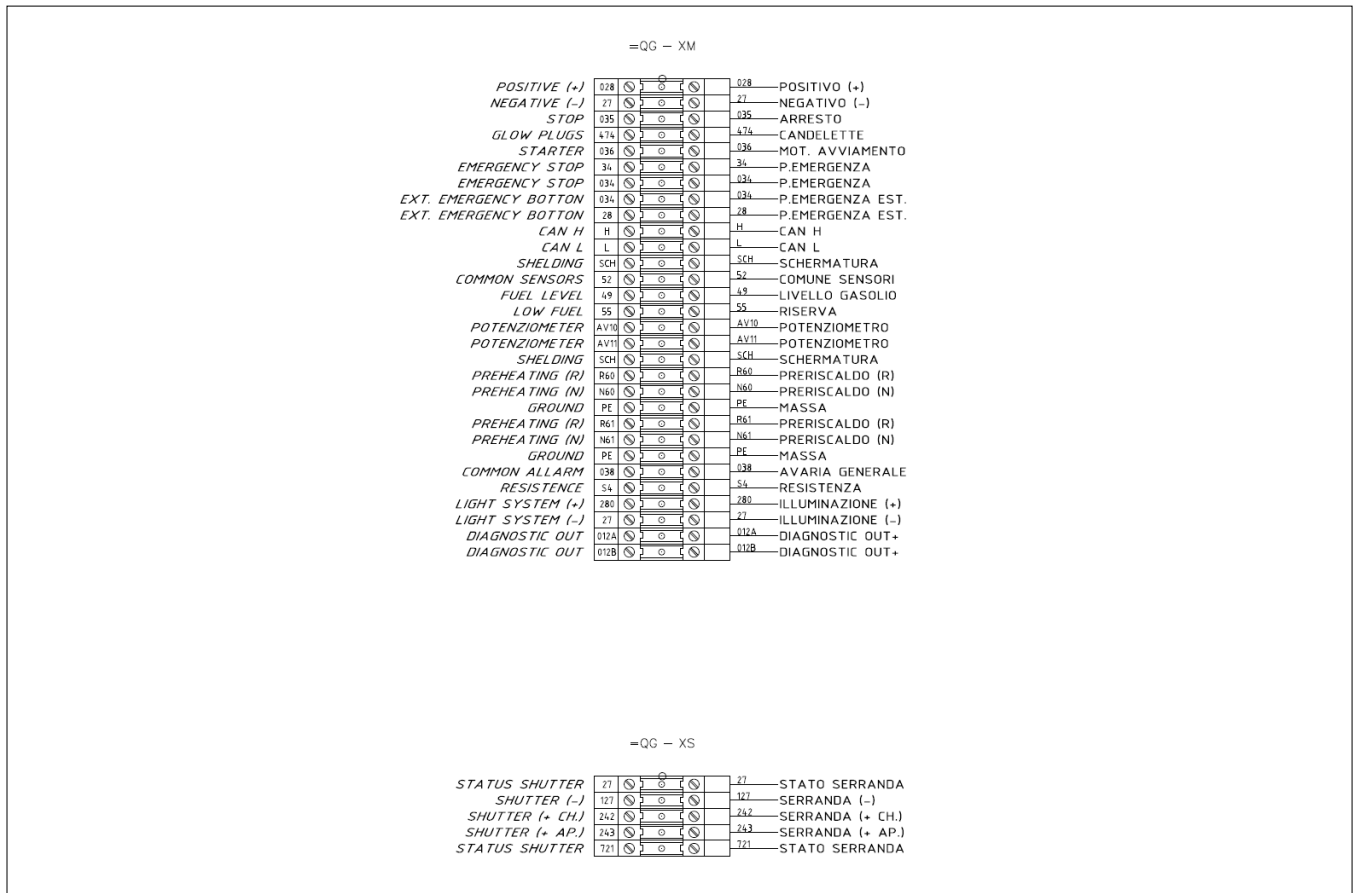

13. Layout

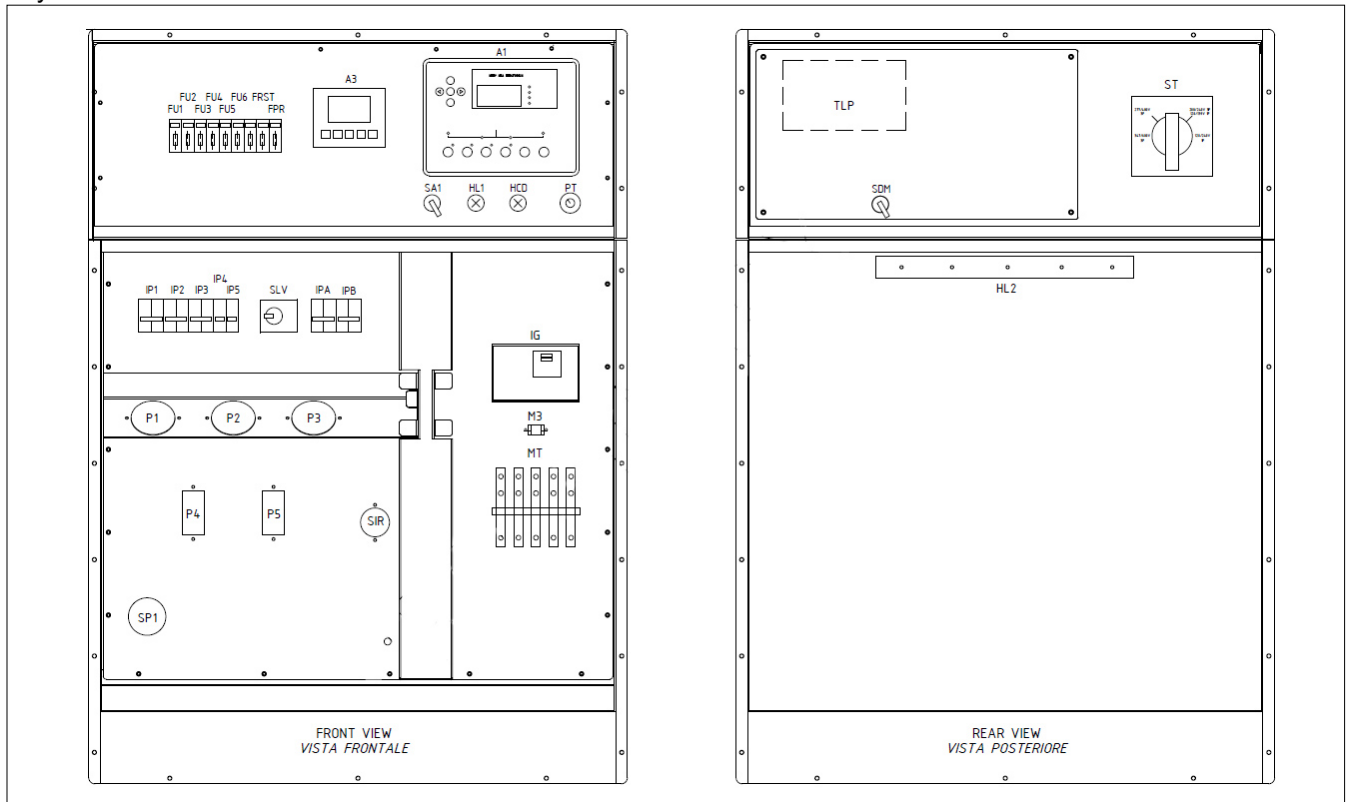

14. Engine Schematic 1

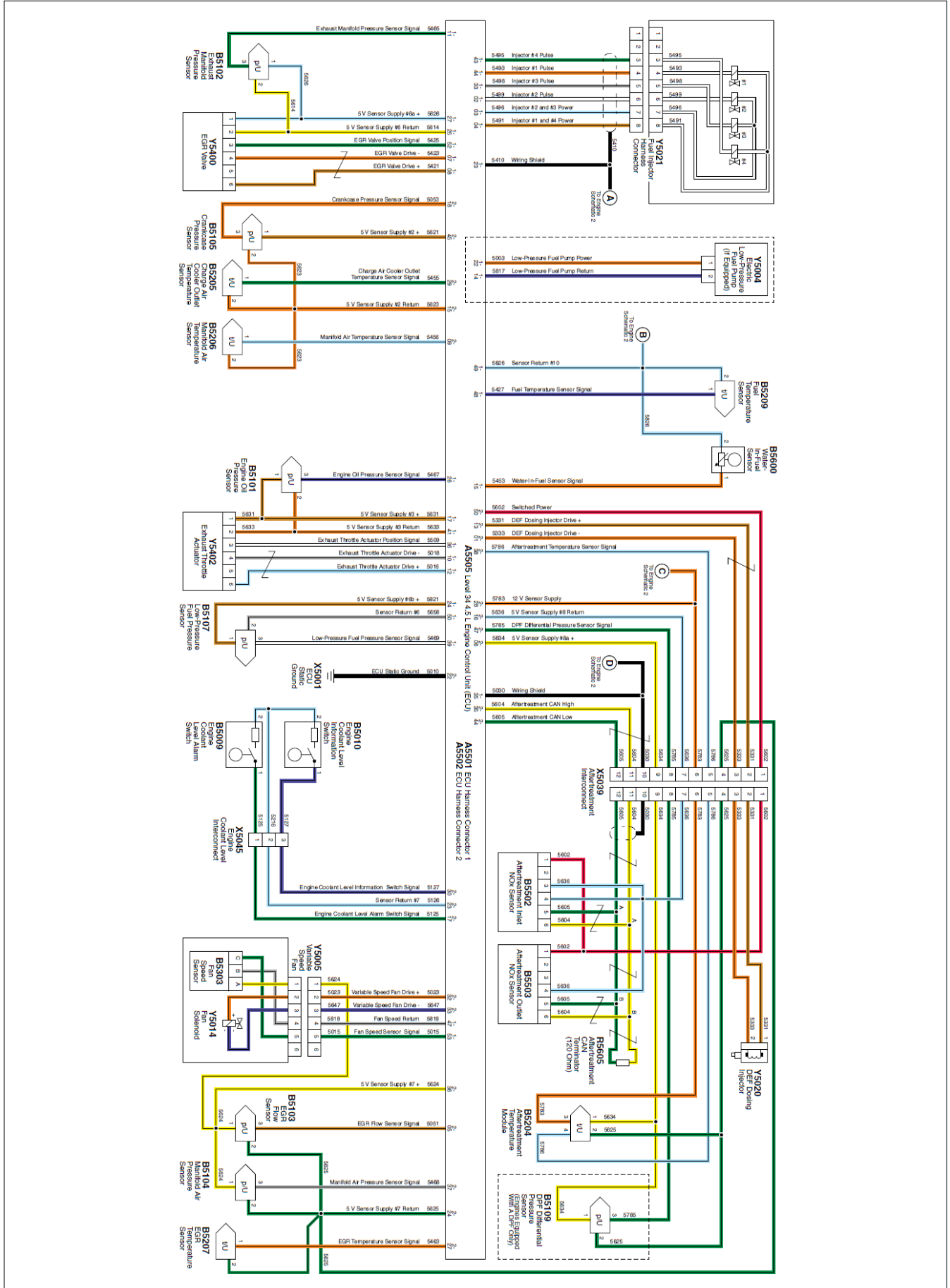

A— To Engine Schematic 2	A5501-39— [5469 White] Low-Pressure Fuel Pressure Sensor Signal	A5502-24— [5625 Green] 5 V Sensor Supply #7 Return	B5103— EGR Flow Sensor
A5501— ECU Harness Connector 1	A5501-41— [5633 Orange] 5 V Sensor Supply #3 Return	A5502-27— [5463 Orange] EGR Temperature Sensor Signal	B5104— Manifold Air Pressure Sensor
A5501-02— [5499 White] Injector #2 Pulse	A5501-43— [5495 Green] Injector #4 Pulse	A5502-28— [5783 Orange] 12 V Sensor Supply	B5105— Crankcase Pressure Sensor
A5501-03— [5496 Blue] Injector #2 and #3 Power	A5501-44— [5493 Orange] Injector #1 Pulse	A5502-29— [5455 Green] Charge Air Cooler Outlet Temperature Sensor Signal	B5107— Low-Pressure Fuel Pressure Sensor
A5501-04— [5491 Brown] Injector #1 and #4 Power	A5501-47— [5818 Gray] Fan Speed Return	A5502-30— [5127 Violet] Engine Coolant Level Information Switch Signal	B5109— DPF Differential Pressure Sensor (Engines Equipped With A DPF Only)
A5501-07— [5423 Orange] EGR Valve Drive Negative	A5501-48— [5427 Violet] Fuel Temperature Sensor Signal	A5502-32— [5023 Orange] Variable Speed Fan Drive Positive	B5204— Aftertreatment Temperature Module
A5501-08— [5421 Brown] EGR Valve Drive Positive	A5501-49— [5826 Blue] Sensor Return #10	A5502-33— [5647 Violet] Variable Speed Fan Drive Negative	B5205— Charge Air Cooler Outlet Temperature Sensor
A5501-10— [5018 Gray] Exhaust Throttle Actuator Drive Negative	A5501-50— [5658 Gray] Sensor Return #6	A5502-35— [5604 Yellow] Aftertreatment CAN High	B5206— Manifold Air Temperature Sensor
A5501-11— [5465 Green] Exhaust Manifold Pressure Sensor Signal	A5501-52— [5425 Green] EGR Valve Position Sensor Signal	A5502-36— [5624 Yellow] 5 V Sensor Supply #7 Positive	B5207— EGR Temperature Sensor
A5501-12— [5016 Blue] Exhaust Throttle Actuator Drive Positive	A5501-53— [5015 Green] Fan Speed Sensor Signal	A5502-37— [5468 Gray] Manifold Air Pressure Sensor Signal	B5209— Fuel Temperature Sensor
A5501-14— [5817 Violet] Low-Pressure Fuel Pump Return	A5502— ECU Harness Connector 2	A5502-38— [5786 Blue] Aftertreatment Temperature Sensor Signal	B5303— Fan Speed Sensor
A5501-15— [5453 Orange] Water-In-Fuel Sensor Signal	A5502-01— [5333 Orange] DEF Dosing Injector Drive Negative	A5502-44— [5605 Green] Aftertreatment CAN Low	B5502— Aftertreatment Inlet NOx Sensor
A5501-17— [5631 Brown] 5 V Sensor Supply #3 Positive	A5502-05— [5051 Brown] EGR Flow Sensor Signal	A5502-45— [5621 Brown] 5 V Sensor Supply #2 Positive	B5503— Aftertreatment Outlet NOx Sensor
A5501-22— [5003 Orange] Low-Pressure Fuel Pump Power	A5502-06— [5634 Yellow] 5 V Sensor Supply #8a Positive	A5502-47— [5785 Green] DPF Differential Pressure Sensor Signal	B5600— Water-In-Fuel Sensor
A5501-23— [5410 Black] Wiring Shield	A5502-09— [5456 Blue] Manifold Air Temperature Sensor Signal	A5502-50— [5602 Red] Switched Power	C— To Engine Schematic 2
A5501-24— [5821 Brown] 5 V Sensor Supply #6b Positive	A5502-13— [5331 Brown] DEF Dosing Injector Drive Positive	A5505— Level 34 4.5 L Engine Control Unit (ECU)	D— To Engine Schematic 2
A5501-25— [5614 Yellow] 5 V Sensor Supply #6 Return	A5502-15— [5623 Orange] 5 V Sensor Supply #2 Return	B5009— Engine Coolant Level Alarm Switch	R5605— Aftertreatment CAN Terminator (120 Ohm)
A5501-26— [5467 Violet] Engine Oil Pressure Sensor Signal	A5502-16— [5636 Blue] 5 V Sensor Supply #8 Return	B5010— Engine Coolant Level Information Switch	X5001— ECU Static Ground
A5501-27— [5626 Blue] 5 V Sensor Supply #6a Positive	A5502-17— [5125 Green] Engine Coolant Level Alarm Switch Signal	B5101— Engine Oil Pressure Sensor	X5039— Aftertreatment Interconnect
A5501-33— [5498 Gray] Injector #3 Pulse	A5502-18— [5053 Orange] Crankcase Pressure Sensor Signal	B5102— Exhaust Manifold Pressure Sensor	X5045— Engine Coolant Level Interconnect
A5501-35— [5030 Black] Wiring Shield	A5502-22— [5010 Black] ECU Static Ground		Y5004— Electric Low-Pressure Fuel Pump (If Equipped)
A5501-36— [5509 White] Exhaust Throttle Actuator Position Signal	A5502-23— [5126 Blue] Sensor Return #7		Y5005— Variable Speed Fan

15. Engine Schematic 2

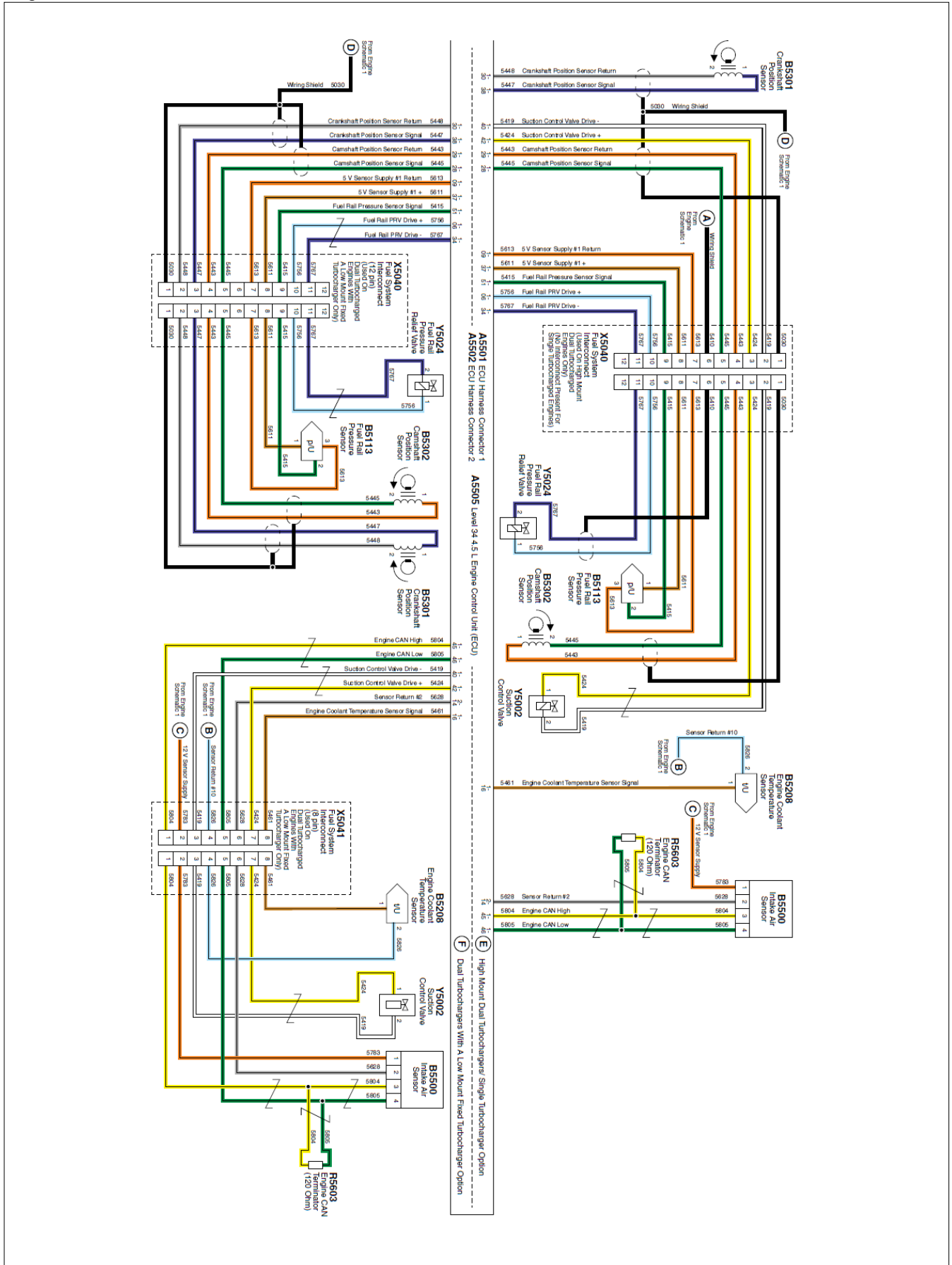

A— [5410 Black] Wiring Shield From Engine Schematic 1	A5501-37— [5611 Brown] 5 V Sensor Supply #1 Positive	B— [5826 Blue] Sensor Return #10 From Engine Schematic 1	X5040— Fuel System Interconnect (Used On High Mount Dual Turbocharged Engines Only) (No Interconnect Present For Single Turbocharged Engines)
A5501— ECU Harness Connector 1	A5501-38— [5447 Violet] Crankshaft Position Sensor Signal	B5208— Engine Coolant Temperature Sensor	
A5501-06— [5756 Blue] Fuel Rail Pressure Relief Valve Drive Positive	A5501-40— [5419 White] Suction Control Valve Drive Negative	B5113— Fuel Rail Pressure Sensor	X5040— Fuel System Interconnect (12 pin) (Used On Dual Turbocharged Engines With A Low Mount Fixed Turbocharger Only)
A5501-09— [5613 Orange] 5 V Sensor Supply #1 Return	A5501-42— [5424 Yellow] Suction Control Valve Drive Positive	B5301— Crankshaft Position Sensor	X5041— Fuel System Interconnect (8 pin) (Used On Dual Turbocharged Engines With A Low Mount Fixed Turbocharger Only)
A5501-16— [5461 Brown] Engine Coolant Temperature Sensor Signal	A5501-45— [5804 Yellow] Engine CAN High	B5302— Camshaft Position Sensor	Y5002— Suction Control Valve
A5501-28— [5445 Green] Camshaft Position Sensor Signal	A5501-46— [5805 Green] Engine CAN Low	B5500— Intake Air Sensor	Y5024— Fuel Rail Pressure Relief Valve
A5501-29— [5443 Orange] Camshaft Position Sensor Return	A5501-51— [5415 Green] Fuel Rail Pressure Sensor Signal	C— [5783 Orange] 12 V Sensor Supply From Engine Schematic 1	
A5501-30— [5448 Gray] Crankshaft Position Sensor Return	A5502— ECU Harness Connector 2	D— [5030 Black] Wiring Shield From Engine Schematic 1	
A5501-34— [5767 Violet] Fuel Rail Pressure Relief Valve Drive Negative	A5502-14— [5628 Gray] Sensor Return #2	E— High Mount Dual Turbochargers/ Single Turbocharger Option	
	A5505— Level 34 4.5 L Engine Control Unit (ECU)	F— Dual Turbochargers With A Low Mount Fixed Turbocharger Option	
		R5603— Engine CAN Terminator (120 Ohm)	

A5501— ECU Harness Connector 1	A5502-53— [5307 Violet] DEF Dosing Unit Reversing Valve Drive Positive	A5503-30— [5034 Yellow] Starter Relay Control Positive	E5602— DEF Dosing Unit Supply Line Heater
A5501-21— [5646 Blue] Sensor Return #1	A5502-54— [5301 Brown] DEF Dosing Unit Heater Positive	A5503-31— [5923 Orange] Bump Enable Switch	E5603— DEF Dosing Unit Return Line Heater
A5501-32— [5671 Brown] Cold Start Aid Drive Positive	A5503— ECU Harness Connector 3	A5503-32— [5941 Brown] External Shutdown Switch	F5000— Control Panel Fuse (30 A)
A5501-54— [5429 White] Cold Start Aid Signal	A5503-01— [5905 Green] Primary CAN Low	A5503-33— [5816 Blue] Cruise Brake Switch	F5004— JD Link Fuse (10 A)
A5502— ECU Harness Connector 2	A5503-02— [5904 Yellow] Primary CAN High	A5503-34— [5648 Gray] Sensor Return #5	F5005— ECU Power Fuse (25 A)
A5502-07— [5141 Brown] 5 V Sensor Supply #8b Positive	A5503-03— [5024 Yellow] Remote Throttle	A5503-35— [5796 Blue] DPF Regeneration Status Lamp	F5006— ECU Power Fuse (25 A)
A5502-10— [5311 Brown] DEF Dosing Unit Pressure Line Heater Positive	A5503-04— [5798 Gray] DPF Regeneration Required Lamp	A5503-36— [5814 Yellow] 5 V Sensor Supply #4 Return	F5007— ECU Power Fuse (25 A)
A5502-11— [5314 Yellow] DEF Dosing Unit Supply Line Heater Positive	A5503-05— [5025 Green] Exhaust Temperature High Lamp	A5503-37— [5936 Blue] Cruise Resume/Bump Down Switch	F5010— Transient Voltage Protection Fuse (30 A)
A5502-12— [5317 Violet] DEF Dosing Unit Return Line Heater Positive	A5503-06— [5918 Gray] Shutdown Override Switch	A5503-38— [5038 Gray] DPF Regeneration Request Switch	F5013— Cold Start Aid Fuse (50 A or 125 A)
A5502-19— [5218 Gray] DEF Tank Fluid Temperature Signal	A5503-07— [5012 Red] Key Switch	A5503-39— [5947 Violet] Digital Throttle	G5000— Battery
A5502-20— [5321 Brown] DEF Coolant Control Valve Drive Positive	A5503-08— [5981 Brown] PWM Throttle/Alternator Feedback	A5503-40— [5773 Orange] Spare Driver Positive	G5001— Alternator
A5502-21— [5304 Yellow] DEF Dosing Unit Pump Drive Positive	A5503-09— [5913 Orange] Secondary Throttle	A5503-41— [5956 Blue] Set Accelerator/Bump Up Switch	K5801— Starter Relay
A5502-25— [5306 Blue] DEF Dosing Unit Pump Position Signal	A5503-10— [5915 Green] Primary Throttle	A5503-42— [5037 Violet] DPF Regeneration Inhibit/Abort Switch	K5801-1— [5777 Violet] Starter Excitation
A5502-31— [5305 Green] DEF Dosing Unit Pump Drive Negative	A5503-11— [5954 Yellow] Cruise On Switch	A5503-43— [5050 Black] Battery Negative	K5803— Cold Start Aid Relay
A5502-34— [5426 Blue] Alternator Excitation	A5503-12— [5022 Red] ECU Power Positive	A5503-44— [5050 Black] Battery Negative	R5601— Primary CAN Terminator
A5502-39— [5313 Orange] DEF Dosing Unit Pressure Line Heater Negative	A5503-13— [5122 Red] ECU Power Positive	A5503-45— [5815 Green] AC Compressor	R5604— Cold Start Aid Interconnect
A5502-40— [5308 Gray] DEF Dosing Unit Reversing Valve Drive Negative	A5503-14— [5122 Red] ECU Power Positive	A5503-46— [5937 Violet] Isochronous Governor	R5607— Cold Start Aid Resistor (1.5 K Ohm, 1 W)
A5502-41— [5318 Gray] DEF Dosing Unit Return Line Heater Negative	A5503-15— [5916 Blue] Warning Lamp	A5503-47— [5473 Orange] Stop Lamp	R5609— Cold Start Aid Resistor (1.5 K Ohm, 1 W)
A5502-42— [5315 Green] DEF Dosing Unit Supply Line Heater Negative	A5503-16— [5050 Black] Battery Negative	A5503-48— [5714 Yellow] 5 V Sensor Supply #5 Return	V5700— Transient Voltage Protection
A5502-43— [5146 Blue] Sensor Return #13	A5503-17— [5050 Black] Battery Negative	A5503-49— [5616 Blue] 5 V Sensor Supply #4 Positive	X5005— Diagnostic Connector
A5502-46— [5309 White] DEF Dosing Unit Pressure Sensor Signal	A5503-18— [5917 Violet] Cruise Remote Switch	A5503-50— [5022 Red] ECU Power Positive	X5007— Remote On/Off
A5502-48— [5136 Blue] Sensor Return #14	A5503-19— [5027 Violet] Air Filter Switch	A5503-51— [5041 Brown] DPF Regeneration Inhibit/Abort Lamp	X5020— Auxiliary Connector
A5502-49— [5329 White] DEF Tank Fluid Level Sensor Signal	A5503-20— [5044 Yellow] Wait to Start Lamp	A5503-52— [5047 Violet] Spare Driver Positive	X5021— Control Panel Connector
A5502-51— [5324 Yellow] DEF Coolant Control Valve Drive Negative	A5503-21— [5020 Black] Primary CAN Shield	A5503-53— [5039 White] Vehicle Speed Input	X5021-B— [5032 Red] Fused Unswitched Power
A5502-52— [5303 Orange] DEF Dosing Unit Heater Negative	A5503-22— [5017 Violet] AC High Pressure Switch	A5503-54— [5971 Brown] Cruise Cancel/Resume Switch	X5021-D— [5422 Red] Start
	A5503-23— [5222 Red] ECU Power Positive	A5505— Level 34 4.5 L Engine Control Unit (ECU)	X5021-J— [5412 Red] Accessory
	A5503-24— [5222 Red] ECU Power Positive	A5507— DEF Tank Header Assembly	X5022— Regeneration Connector
	A5503-25— [5439 White] Tachometer	B5211— DEF Tank Fluid Temperature Sensor	X5025— JD Link Connector
	A5503-26— [5029 White] Starter Relay Control Negative	B5501— DEF Dosing Unit	X5037— DEF Dosing Unit Interconnect
	A5503-27— [5050 Black] Battery Negative	B5601— DEF Tank Fluid Level Sensor	X5038— DEF Dosing System Interconnect
	A5503-28— [5911 Brown] 5 V Sensor Supply #5 Positive	E5601— DEF Dosing Unit Pressure Line Heater	X5069— Fuse Block Assembly
	A5503-29— [5939 White] External Derate Switch		X5069-B3— [5002 Red] Control Panel Unswitched Power

megagen

Phone: 1 (866) 918-6976

service@axiomequipmentgroup.com